

TOSHIBA

OWNER'S MANUAL
3LCD PROJECTOR

TLP-ET1B

TLP-ET1E

TLP-ET1U

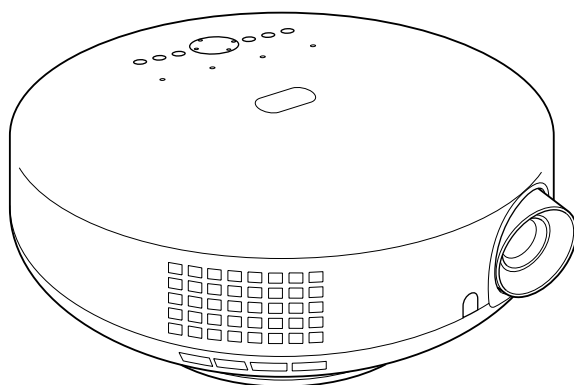

English

Before Using

Preparations

Operations

Maintenance

Others

Before Using

SAFETY PRECAUTIONS

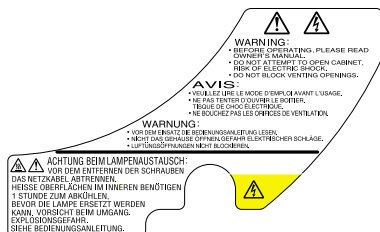

The lightning flash with arrowhead symbol, within an equilateral triangle, is intended to alert the user to the presence of uninsulated "dangerous voltage" within the product's enclosure that may be of sufficient magnitude to constitute a risk of electric shock to persons.



The exclamation point within an equilateral triangle is intended to alert the user to the presence of important operating and maintenance (servicing) instructions in the literature accompanying the appliance.

WARNING: TO REDUCE THE RISK OF FIRE OR ELECTRIC SHOCK, DO NOT EXPOSE THIS APPLIANCE TO RAIN OR MOISTURE. DANGEROUS HIGH VOLTAGES ARE PRESENT INSIDE THE ENCLOSURE. DO NOT OPEN THE CABINET. REFER SERVICING TO QUALIFIED PERSONNEL ONLY.

WARNING: Handling the cord on this product or cords associated with accessories sold with this product, will expose you to lead, a chemical known to the State of California to cause birth defects or other reproductive harm. **Wash hands after handling.**

USA only

FCC Radio Frequency Interference Statement

Note: This equipment has been tested and found to comply with the limits for a Class B digital device, pursuant to part 15 of the FCC Rules. These limits are designed to provide reasonable protection against harmful interference in a residential installation.

USA only

This equipment generates, uses, and can radiate radio frequency energy and, if not installed and used in accordance with the instructions, may cause harmful interference to radio communications.

However, there is no guarantee that interference will not occur in a particular installation.

If this equipment does cause harmful interference to radio or television reception, which can be determined by turning the equipment off and on, the user is encouraged to try to correct the interference by one or more of the following measures:

- Reorient or relocate the receiving antenna.
- Increase the separation between the equipment and receiver.
- Connect the equipment into an outlet on a circuit different from that to which the receiver is connected.
- Consult the dealer or an experienced radio/TV technician for help.

WARNING: Changes or modifications made to this equipment, not expressly approved by Toshiba, or parties authorized by Toshiba, could void the user's authority to operate the equipment.

USA only

Notice: This Class B digital apparatus complies with Canadian ICES-003.
Cet appareil numérique de la classe B est conforme à la norme NMB-003 du Canada.

CANADA only

IMPORTANT SAFETY INSTRUCTIONS

CAUTION: PLEASE READ AND OBSERVE ALL WARNINGS AND INSTRUCTIONS PROVIDED IN THIS OWNER'S MANUAL AND THOSE MARKED ON THE UNIT. KEEP THIS BOOKLET FOR FUTURE REFERENCE.

This set has been designed and manufactured to assure personal safety. Improper use can result in electric shock or fire hazard. The safeguards incorporated in this unit will protect you if you observe the following procedures for installation, use and servicing. This unit is fully transistorized and does not contain any parts that can be repaired by the user.

DO NOT REMOVE THE CABINET COVER, OR YOU MAY BE EXPOSED TO DANGEROUS VOLTAGE. REFER SERVICING TO QUALIFIED SERVICE PERSONNEL ONLY.

1. Read Owner's Manual

After unpacking this product, read the owner's manual carefully, and follow all the operating and other instructions.



2. Power Sources

This product should be operated only from the type of power source indicated on the marking label.

If you are not sure of the type of power supply to your home, consult your product dealer or local power company.

For products intended to operate from battery power, or other sources, refer to the operating instructions.



3. Source of Light

Do not look into the lens while the lamp is on. The strong light from the lamp may cause damage to your eyes or sight.



4. Ventilation

Openings in the cabinet are provided for ventilation and to ensure reliable operation of the product and to protect it from overheating, and these openings must not be blocked or covered. The openings should never be blocked by placing the product on a bed, sofa, rug or other similar surface. This product should not be placed in a built-in installation such as a bookcase or rack unless proper ventilation is provided or the manufacturer's instructions have been followed.



5. Heat

The product should be situated away from heat sources such as radiators, heat registers, stoves, or other products (including amplifiers) that produce heat.

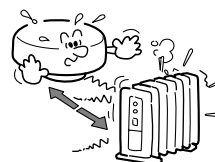

6. Water and Moisture

Do not use this product near water. - for example, near a bath tub, wash bowl, kitchen sink, or laundry tub; in a wet basement; or near a swimming pool and the like.



Before Using

IMPORTANT SAFETY INSTRUCTIONS (Continued)

7. Cleaning

Unplug this product from the wall outlet before cleaning. Do not use liquid cleaners or aerosol cleaners.

Use a soft cloth for cleaning.



8. Power-Cord Protection

Power-supply cords should be routed so that they are not likely to be walked on or pinched by items placed upon or against them, paying particular attention to cords at plugs, convenience receptacles, and the point where they exit from the product.



9. Overloading

Do not overload wall outlets, extension cords, or integral convenience receptacles as this can result in a risk of fire or electric shock.



10. Lightning storms

For added protection for this product during a storm, or when it is left unattended and unused for long periods of time, unplug it from the wall outlet. This will prevent damage to the product due to lightning and power-line surges.

When lightning starts, do not touch this product, the connection cable, or the power code plug.

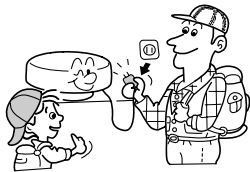

11. Object and Liquid Entry

Never push objects of any kind into this product through openings as they may touch dangerous voltage points or short-out parts that could result in a fire or electric shock. Never spill liquid of any kind on the product.



12. Do not place the product vertically

Do not use the product in the upright position to project the pictures at the ceiling, or any other vertical positions. It may fall down.

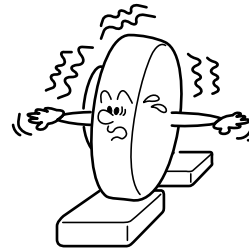

13. Stack Inhibited

Do not stack other equipment on this product or do not place this product on the other equipment. Top and bottom plates of this product may develop heat and damage other equipment.



14. Attachments

Do not use attachments not recommended by the product manufacturer as they may cause a hazard.

15. Accessories

Do not place this product on an unstable cart, stand, tripod, bracket, or table. The product may fall, causing serious injury to a child or adult, and serious damage to the product. Use only with a cart, stand, tripod, bracket, or table recommended by the manufacturer, or sold with the product. Any mounting of the product should follow the manufacturer's instructions, and should use a mounting accessory recommended by the manufacturer. A product and cart combination should be moved with care. Quick stops, excessive force, and uneven surfaces may cause the product and cart combination to overturn.



16. Damage Requiring Service

Unplug this product from the wall outlet and refer servicing to qualified service personnel under the following conditions:

- When the power-supply cord or plug is damaged.
- If liquid has been spilled, or objects have fallen into the product.
- If the product has been exposed to rain or water.
- If the product does not operate normally by following the operating instructions. Adjust only those controls that are covered by the operating instructions as an improper adjustment of other controls may result in damage and will often require extensive work by a qualified technician to restore the product to its normal operation.
- If the product has been dropped or damaged in any way.
- When the product exhibits a distinct change in performance.

17. If glass components, including lens and lamp, should break, contact your dealer for repair service.

This product incorporates glass components, including a lens and a lamp. If such parts should break, please handle with care to avoid injury and contact your dealer for repair service. The broken pieces of glass may cause injury. In the unlikely event of the lamp rupturing, thoroughly clean the area around the projector.

18. Servicing

Do not attempt to service this product yourself as opening or removing covers may expose you to dangerous voltage or other hazards. Refer all servicing to qualified service personnel.



19. Replacement Parts

When replacement parts are required, be sure the service technician has used replacement parts specified by the manufacturer or have the same characteristics as the original part. Unauthorized substitutions may result in fire, electric shock, or other hazards. (The only part the user should replace is the lamp.)

20. Safety Check

Upon completion of any service or repairs to this product, ask the service technician to perform safety checks to determine that the product is in proper operating condition.

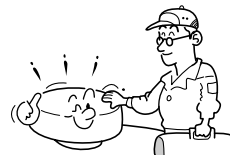

21. Do not leave thermal-paper documents or easily damaged items on top of the unit or near the air exhaust for long periods of time.

The heat from the unit could erase the information on the thermal paper, or cause damage or warping. Also, when you touch a metal object put near the air exhaust, it could be hot and burn you.

Before Using

IMPORTANT SAFETY INSTRUCTIONS (Continued)

22. If smoke is coming out of this product or you could smell something, unplug the power cord plug from the wall outlet.

Wait until you can confirm that no more smoke is coming out, and then contact your product dealer. Using this product without taking the action mentioned above may cause a fire or an electric shock.

23. If you wish to install the projector to the ceiling, replace a lamp or clean a filter of the ceiling mounted projector and the like, be sure to ask your product dealer to do so.

Doing these things by yourself may cause injury due to a fall, etc.

LABEL LOCATIONS

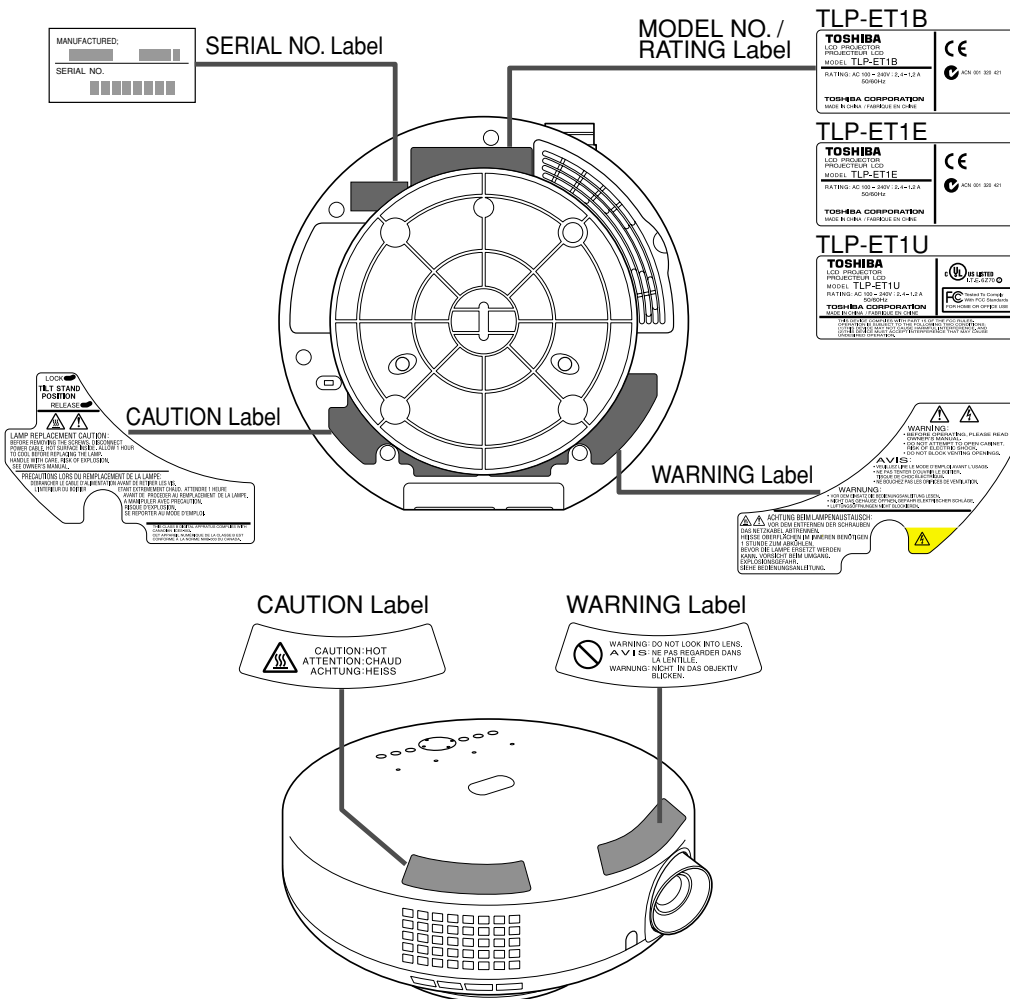

IMPORTANT PRECAUTIONS

Save Original Packing Materials

The original shipping carton and packing materials will come in handy if you ever have to ship your LCD projector. For maximum protection, repack the set as it was originally packed at the factory.

Moisture Condensation

Never operate this unit immediately after moving it from a cold location to a warm location. When the unit is exposed to such a change in temperature, moisture may condense on the crucial internal parts. To prevent the unit from possible damage, do not use the unit for at least 2 hours when there is an extreme or sudden change in temperature.

Place and Manner of Installation

- Do not place the projector in hot locations, such as near heating equipment. Doing so could cause malfunction, and shorten the life of the LCD panel.
- Avoid locations with oil or cigarette smoke. Doing so will dirty the LCD panel and other optical parts, shortening their lives, and darkening the screen.
- Do not place slantwise in angle of 20° or more. Doing so could shorten the life of the lamp.
- Using this product near a TV or radio may cause interference to the images or audio sound. If this happens, move it away from the TV or radio.
- Moving the projector from a low-temperature room to a high-temperature room may cause condensation on the lens or internal parts of the product. If you continue to use it in that situation, the malfunction may result. Ensure to wait until the condensation naturally disappears.
- In a high altitude location where air is thin, cooling efficiency of the projector is reduced. In this case, lower the ambient temperature and use it.

Avoid Volatile Liquid

Do not use volatile liquids, such as an insect spray, near the unit. Do not leave rubber or plastic products touching the unit for a long time. They will leave marks on the finish.

If cleaning with a chemically saturated cloth, be sure to follow the product's precautions.

LCD Panel

The life of the LCD panel is limited. Take care over the points below so as to use the panel for years.

- To prolong the life of this panel, never fail to turn the power off when the panel is not in use and make sure that the lamp has gone out. The state of the lamp being extinguished helps enhance the effect of energy saving.
- If the air filter is stained and is clogged up, the main unit inner temperature rises. As a result, the life of the LCD is shortened and a malfunction may also occur.

Clean the air filter from time to time and replace it regularly. It is recommended that this replacement be done at the time of replacing a lamp. (Ask a dealer where the unit was purchased or your nearby service station about an air filter for replacement.)

In the spaces provided below, record the Model and Serial No. located at the bottom of your LCD projector.

Model No. _____ Serial No. _____

Retain this information for future reference.

EXEMPTION CLAUSES

- Toshiba Corporation bears no responsibility in the case of damages arising from natural disaster (such as earthquakes, lightning, etc.), fires not liable to Toshiba Corporation, operating by third parties, other accidents, or use under abnormal conditions including erroneous or improper operation and other problems.
- Toshiba Corporation bears no responsibility for incidental damages (lost profit, work interruption, corruption or loss of the memory contents, etc.) arising from the use of or the inability to use this unit.
- Toshiba Corporation accepts no liability whatsoever for any damages arising from not having followed the descriptions in this Instruction Manual.
- Toshiba Corporation accepts no liability whatsoever for any damages arising from malfunctions arising from combination with equipment or software that is not related to Toshiba Corporation.

OTHER CAUTIONS AND INFORMATIONS

Copyrights

Showing or transmitting commercial imaging software or broadcast or cable-broad casting programs with the purpose of other than the personal and private viewing, including modifying images using the freeze or resize functions, or displaying with the varying aspect ratio of the images, could violate the direct or indirect copyrights of the imaging software or broadcast program, etc., if done without first consulting with the copyright holder. For this reason, please take appropriate measures before performing one of the actions listed above, including obtaining a license from the copyright holder.

Disposal

This product contains substances which are harmful to humans and the environment.

- Solder used in the internal parts contains the lead.
- The lamp contains inorganic mercury.

Please dispose of this product or used lamps in accordance with local regulations.

Trademarks

- VGA, SVGA, XGA, SXGA, UXGA are trademarks or registered trademarks of International Business Machines Corporation.
- Windows is a registered trademark of Microsoft Corporation in the U.S. and other countries.
- "DCDi" and "TrueLife by Faroudja" are trademarks of Faroudja, a division of Genesis Microchip Corp.

Notational Conventions Used in This Manual

References to pages with related information are annotated as follows.

For example, if making a reference to page 36: (➡ p.36)

Checking the package contents

Please make sure that the following items are included in the box, along with the main unit. If any item is missing, please contact the store immediately where you purchased the product.

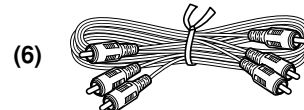
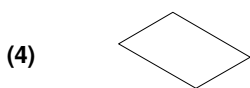
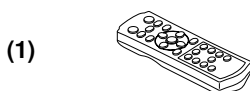

- (1) Remote control
- (2) R03 (SIZE AAA) batteries for remote control
- (3) Owner's Manual (this document)
- (4) Quick Reference
- (5) Power cord (see note)
- (6) AV cable

Note

The shape and number of supplied power cords vary depending on the product destination.

CONTENTS

Before Using

SAFETY PRECAUTIONS 2
 IMPORTANT SAFETY INSTRUCTIONS 3
 LABEL LOCATIONS 6
 IMPORTANT PRECAUTIONS 7
 EXEMPTION CLAUSES 7
 OTHER CAUTIONS AND INFORMATIONS 8
 Checking the package contents 8
 CONTENTS 9
 Selecting the Power Cord 9

Preparations

Parts of the main unit 10
 Parts on the control panel and remote control 11
 Connection terminals 12
 Preparing and using the remote control 13
 Placing the projector 14
 Connecting an input source device 15
 Connecting a video device 15
 Connecting a DVD player with component video terminals 16
 Connecting a computer 16

Operations

Turning the power on and off 17
 Before turning the power on 17
 Turning the power on 18
 Safety lock 18
 Turning the power off 19
 Projecting 20
 Easy setup using the EASY button 22
 Changing the projection size 24
 Changing the screen size 25

Cutting off the sound/Pausing the picture 26
 Cutting off the sound temporarily (Mute) 26
 Cutting off both the picture and sound temporarily (Sleep) 26
 Pausing the picture (Freeze) 26
 Switching the picture and sound 27
 Setting the picture mode 27
 Switching to surround sound 27
 Enlarging the picture (Zoom) 28
 Calling up a user profile 29
 Using the menus 30
 How to use the menus 30
 Picture adjustment menu 32
 Audio adjustment menu 34
 Default setting menu 35
 Status display menu 36
 User memory menu 37

Maintenance

Removing the tilt stand 39
 Air filter cleaning 40
 Lens and main unit cleaning 41
 Lens cleaning 41
 Main unit cleaning 41
 Replacing air intake and exhaust fans, and air filter 41
 Lamp replacement 42

Others

Trouble indications 45
 Before calling service personnel 46
 Specifications 47
 List of general specifications 47
 List of supported signals 48
 Pin assignment of COMPUTER terminal 49
 Separately sold product 49

Selecting the Power Cord

If your voltage is 220 to 240 V, use one of the following types of cable.

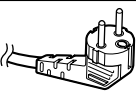
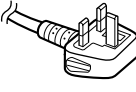
Plug configuration	Plug type	Line voltage
	EURO	220 – 240V
	UK	220 – 240V

Use a 5A fuse which is approved by ASTA or BSI to BSI362.
 Always replace the fuse cover after changing the fuse.

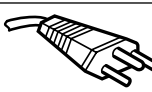
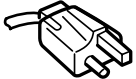
Plug configuration	Plug type	Line voltage
	Australian 240V 10A	200 – 240V
	Switzerland 240V 6A	200 – 240V
	North American 240V 15A	200 – 240V

Parts of the main unit

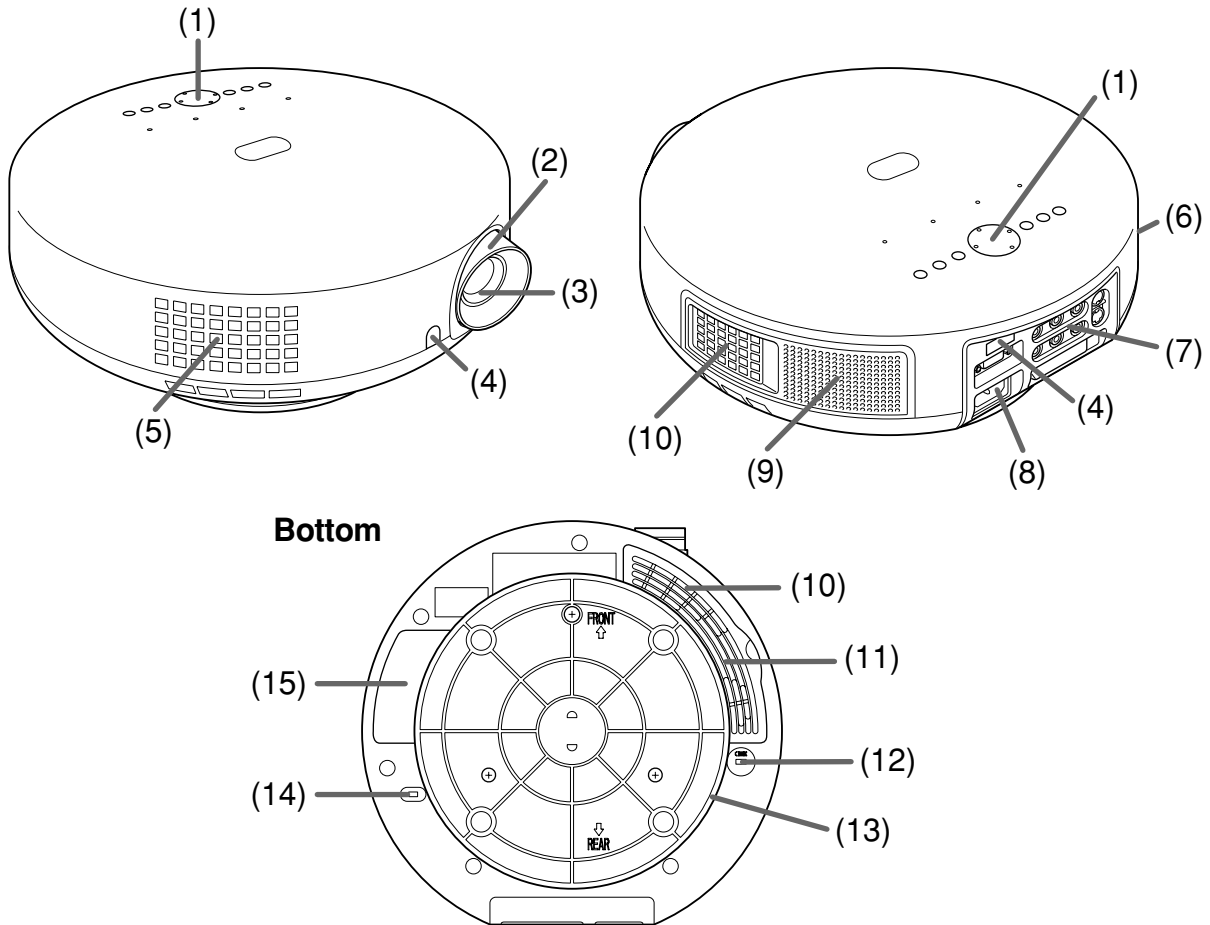

Name	: Function
(1) Control panel	: Operates the projector. (➡ p.11)
(2) Focusing ring	: Adjusts the screen focus. (➡ p.20)
(3) Lens	: Projects an expanded video image.
(4) Infrared remote sensor	: Senses commands from the remote control. (➡ p.13)
(5) Air exhaust	: Expels air that has grown hot inside the unit.
(6) Speaker (Right)	: Plays the sound input to AUDIO terminal (R).
(7) Connection terminals	: Connect external devices. (➡ p.12, 15, 16)
(8) AC IN socket	: Connect the supplied power cord here. (➡ p.17)
(9) Speaker (Left)	: Plays the sound input to AUDIO terminal (L).
(10) Air intake	: Draws in air from outside the unit.
(11) Air filter cover	: Remove when cleaning the air filter. (➡ p.40)
(12) Anti-theft lock hole	: Attach a security chain, etc. here.
(13) Tilt stand	: Adjusts the vertical projection angle and the projector's horizontal tilt. (➡ p.20) This tilt stand is removable. (➡ p.39)
(14) Safety lock switch	: Prevents the projector's power from being turned on accidentally. (➡ p.18)
(15) Lamp cover	: Remove when replacing the lamp. (➡ p.42)

Parts on the control panel and remote control

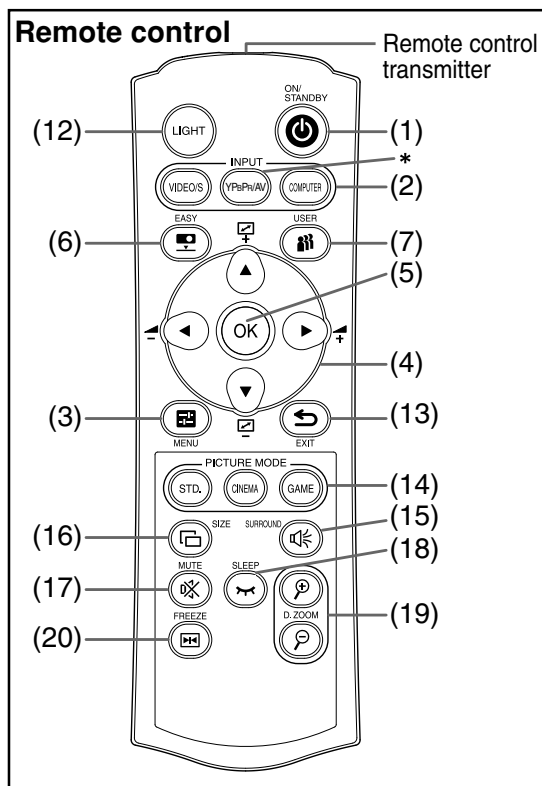
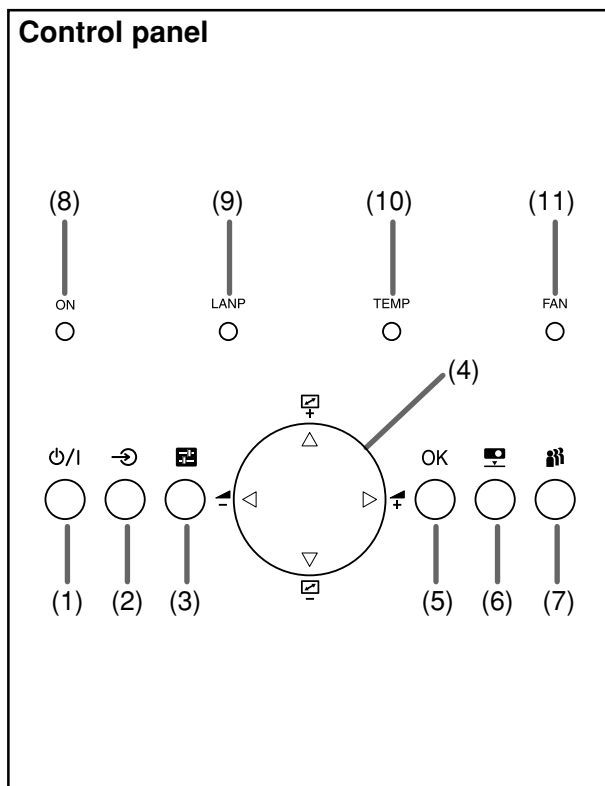

Name : Main function

- | | |
|--|--|
| <p>(1) ON/STANDBY button</p> <p>(2) INPUT buttons</p> <p>(3) MENU button</p> <p>(4) Select buttons</p> <p>(5) OK button</p> <p>(6) EASY button</p> <p>(7) USER button</p> <p>(8) ON indicator</p> <p>(9) LAMP indicator</p> <p>(10) TEMP indicator</p> <p>(11) FAN indicator</p> <p>(12) LIGHT button</p> <p>(13) EXIT button</p> <p>(14) PICTURE MODE button</p> <p>(15) SURROUND button</p> <p>(16) SIZE button</p> <p>(17) MUTE button</p> <p>(18) SLEEP button</p> <p>(19) D.ZOOM button</p> <p>(20) FREEZE button</p> | <p>: Turns the power on/off (standby). (➡ p.18, 19)</p> <p>: Select input. (➡ p.21)</p> <p>: Displays menus. (➡ p.30)</p> <p>: Make menu selections and adjustments, etc. (➡ p.30)
In this manual, select buttons are represented by ▲ ▼ ◀ ▶.</p> <p>: Accepts the current selection, e.g., on a menu. (➡ p.31)</p> <p>: Displays the easy setting menu. (➡ p.22)</p> <p>: Calls up a registered user profile. (➡ p.29)</p> <p>: Shows whether the unit is powered on or standby. (➡ p.17, 18, 45)</p> <p>: Displays the current lamp mode. (➡ p.18, 19, 45)</p> <p>: Lights when internal temperature is too high. (➡ p.45)</p> <p>: Displays the current cooling fan mode. (➡ p.18, 19, 45)</p> <p>: By pressing this button, the operation buttons light up for about 10 seconds. Pressing the button again, while the lights are on, turns off the lights. Pressing another button while the lights are on turns on the lights for another 10 seconds.</p> <p>: Turns off the menu screen, etc. (➡ p.31)</p> <p>: Selects a picture mode. (➡ p.27)</p> <p>: Selects a surround-sound effect mode. (➡ p.27)</p> <p>: Selects a screen size. (➡ p.25)</p> <p>: Cuts off the sound temporarily. (➡ p.26)</p> <p>: Cuts off the picture and sound temporarily. (➡ p.26)</p> <p>: Zooms in or out the image. (➡ p.28)</p> <p>: Pauses the image. (➡ p.26)</p> |
|--|--|

Buttons only on the remote control

* Although the center INPUT button is represented as “YPBPR/AV” in this manual, the button is represented as “YPBPR” on the TLP-ET1U.

Connection terminals

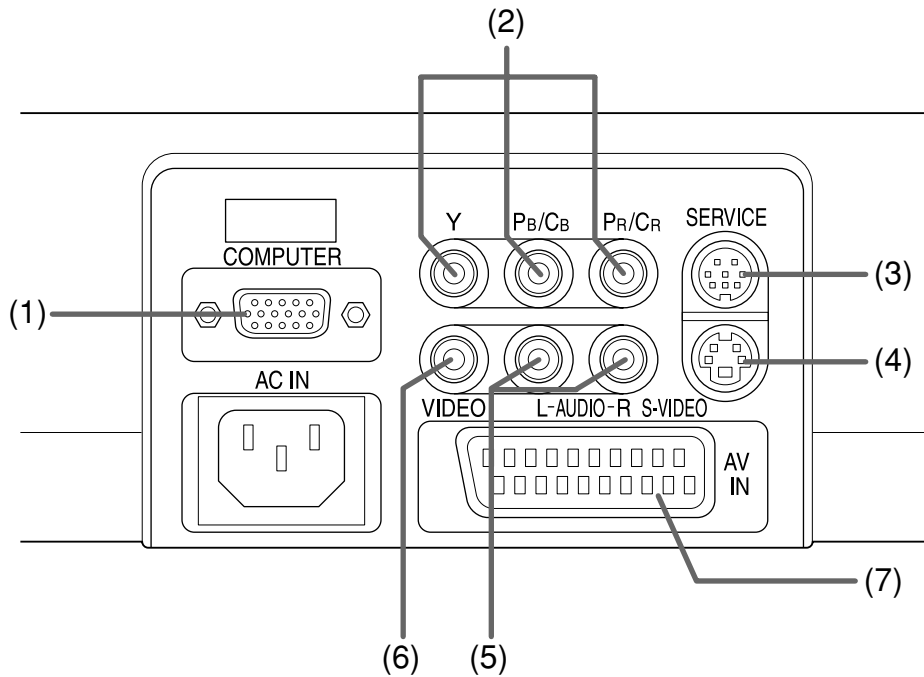

Name	Function
(1) COMPUTER terminal	: Inputs RGB signals from a computer or other equipments.
(2) Y, PB/Cb, and PR/CR terminals	: Input component video signals (Y/PB/PR) from a video device.
(3) SERVICE terminal	: Leave this unconnected. Used for repair purposes.
(4) S-VIDEO terminal	: Inputs S-Video signals from a video device.
(5) AUDIO terminal	: Inputs audio signals from a computer or video device.
(6) VIDEO terminal	: Inputs video signals from a video device.
(7) AV IN terminal*	: Inputs audio and video signals from a video device. The AV IN terminal cannot receive S-Video signals.

Note

- Component video signals are abbreviated as Y/PB/PR in this manual. However, the projector supports signals from a video device whose output signals are represented as Y/CB/CR as well.

* Although the AV IN terminal is included in illustrations in this manual, the terminal exists only on the TLP-ET1B and TLP-ET1E. TLP-ET1U is not equipped with the AV IN terminal. The AV IN terminal automatically identifies the RGB and composite signals. Check the setting on the connected device as well.

Preparing and using the remote control

Loading batteries into the remote control

1 Remove the battery cover.

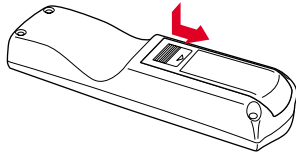

2 Insert dry cell batteries.

Check the positive and negative terminals of each battery to load it correctly.

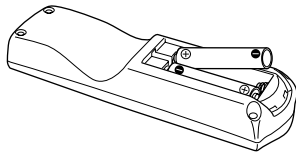

Use two AAA (LR03 or R03) dry cell batteries.

3 Put back the battery cover.

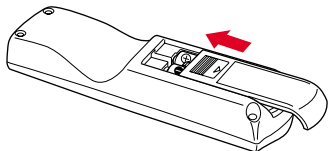

● Dry cell batteries

- Remove the batteries from the remote control when it is not used for an extended period of time.
- If the remote control stops working or its controlling range decreases, replace all the batteries with new ones.

● The remote control

- The remote control may fail to operate if the infrared remote sensor is exposed to bright sunlight or fluorescent lighting.
- Do not drop or bang it.
- Do not leave it in hot or humid locations.
- Do not get it wet or place it on top of wet objects.
- Do not take it apart.
- In rare cases, ambient conditions could impede the operation of the remote control. If this happens, point the remote control at the main unit again, and repeat the operation.

Operating the remote control

Point the remote control toward the projector's infrared remote sensor, and press a button on the remote control.

- Operating the projector from the front

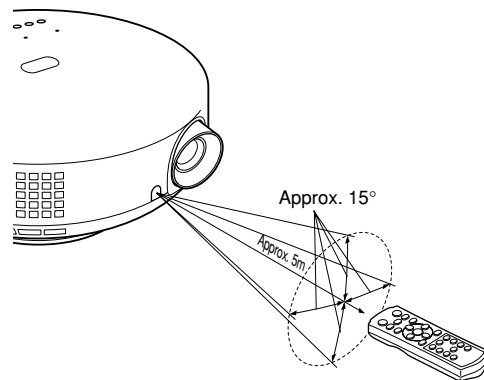

- Operating the projector from the rear

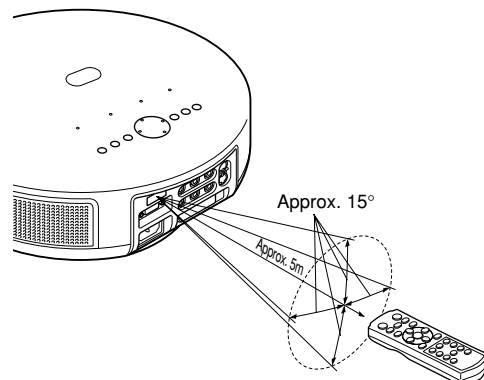

Placing the projector

⚠ CAUTION

- Always obey the instructions listed in IMPORTANT SAFETY INSTRUCTIONS when placing the unit.
- If you wish to mount the projector on the ceiling, be sure to ask your dealer to do so. Mounting the projector on a ceiling requires special ceiling brackets (sold separately) and specialized knowledge. Improper mounting could cause the projector to fall, resulting in an accident.
- If you wish to mount the projector on the ceiling, remove the tilt stand attached to this unit. Mounting the projector with the tilt stand on the ceiling could cause it to fall, resulting in an accident.
- If the projector is ceiling-mounted, install the breaker for turning off the power in case of emergency. Let everyone involved with the use of the projector know that fact.

1 Determine the placement style.

As shown in the figures below, this unit can be placed in four different styles. The factory setting is “Front” and “Standard.” Set “Projection mode 1” and “Projection mode 2” in the “Default setting” menu (see ➡ p.35) in accordance with your needs.

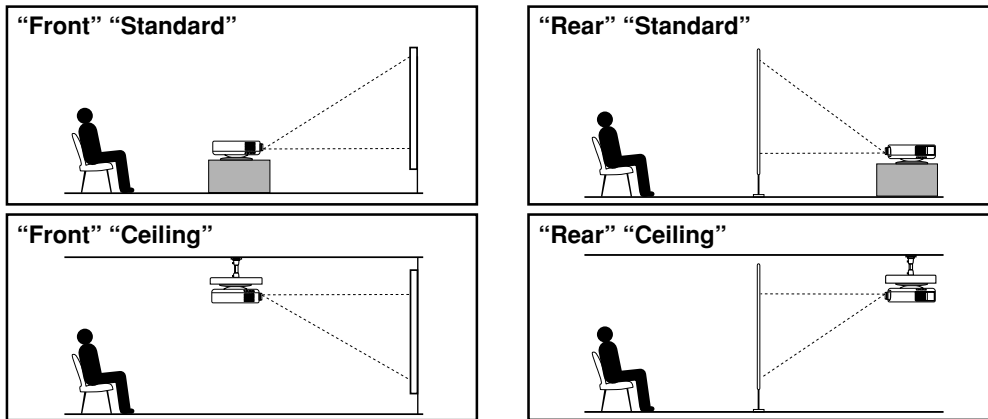

2 Determine the projection distance and place the unit.

Determine the projection distance from the lens to the screen to obtain the desired screen size. (The screen sizes listed below are approximate values for a full-size image projected with no keystone adjustment.)

The screen size decreases as the lens comes closer to the screen; it increases as the lens goes away from the screen.

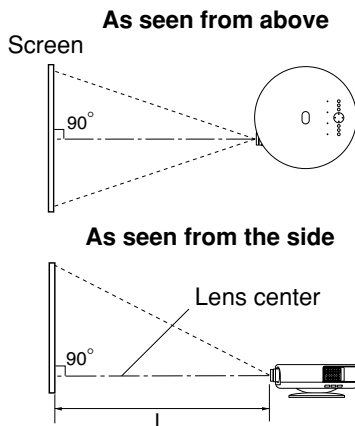

Screen size Inches/ vertical × horizontal (m)	Projection distance L (m)
32 (0.4 × 0.71)	0.74
40 (0.50 × 0.89)	1.00
60 (0.75 × 1.33)	1.51
80 (1.00 × 1.77)	2.03
100 (1.25 × 2.22)	2.54
120 (1.5 × 2.66)	3.04

Reference equation

$$L \text{ (projection distance)} = \frac{\text{Projection size (inches)} - 0.9317}{39.039}$$

“L” is the lens-to-screen distance (m) ranging from approximately 0.74 to 3.04 m.

Connecting an input source device

Before connection

- Read the owner's manual of the device to connect to the projector.
- Turn off the power of both devices before connecting.

Connecting a video device

■ Using the AV or S-Video cable

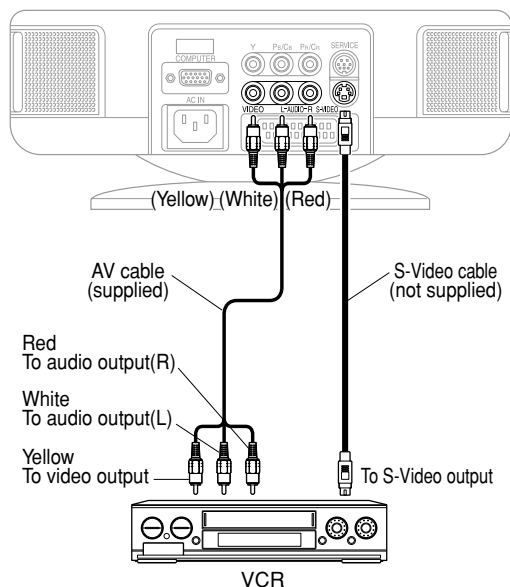

Note

- Use the AV cable or S-Video cable to connect the input device to this unit. When using the S-Video cable, also use an audio cable such as the AV cable to connect the audio input from the video device to the AUDIO terminals on the unit.

■ Using the SCART cable

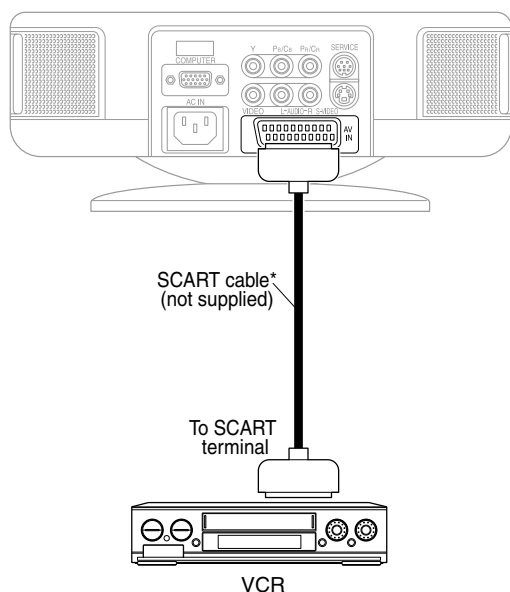

* The TLP-ET1U cannot use the SCART cable for connection since it has no AV IN terminal.

Preparations

Connecting an input source device (Continued)

Connecting a DVD player with component video terminals

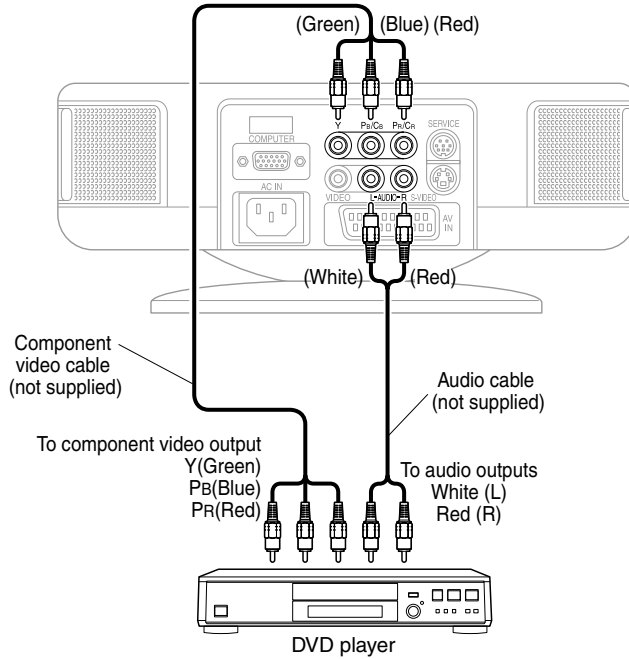

Connecting a computer

- Some types of computer cannot be connected to or used with this projector. Check the computer for an RGB output terminal, supported signal, and so on. (See ➔ p.47.)

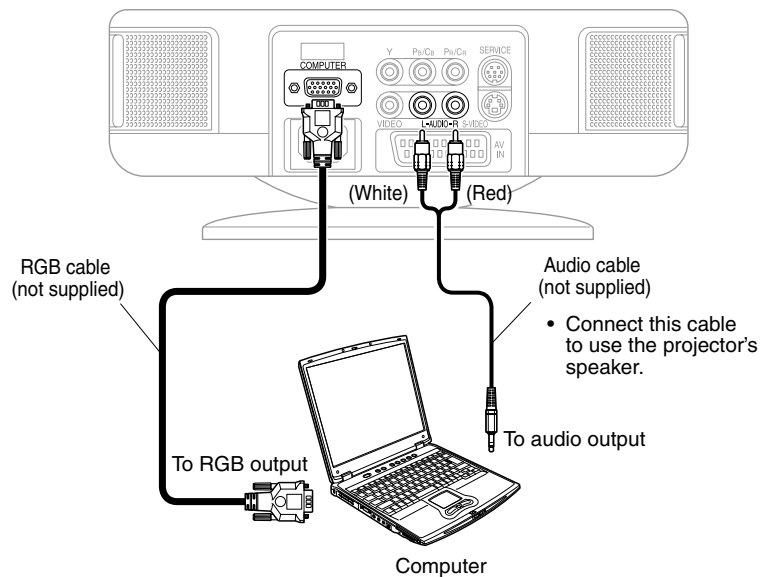

Note

- Moving pictures played with a DVD software player on a computer may look unnatural when projected by this projector, but it is not a malfunction.

Turning the power on and off

Before turning the power on

1 Connect the power cord.

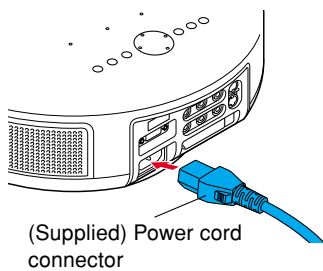

- ① Insert the power cord connector into the AC IN socket on the projector.
- ② Insert the power cord plug into a wall or other power outlet. When the power cord is plugged in, the ON indicator comes on in orange, indicating that the unit is on standby.

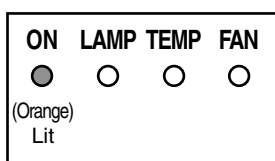

2 Remove the lens cover.

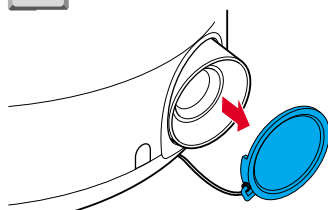

Be sure to remove the lens cover when the power is turned on. If it is left on, it could become deformed due to heat.

LCD Panels

LCD panels wear out. In order to prolong the lifetime of your LCD panel, take the following precautions:

- In order to extend the lifetime of the LCD panel, always turn off the power when not in use, and make sure that the lamp is off. Keeping the lamp off is also very effective at saving electricity.
- If the air filter becomes dirty and clogged, the projector's internal temperature will rise, shortening the lifetime of the LCD panel and causing malfunctions. Clean the air filter from time to time (see ➔ p.40), and replace it periodically. Contact the store where you purchased your projector, or your local Service Station for replacement of the air filters.

The projector's LCD panel is made using extremely advanced technology, but there may be black spots (pixels that do not light) or bright spots (pixels that are constantly lit) on the panel. Please note that these are not malfunctions.

Operations

Turning the power on and off (Continued)

Turning the power on

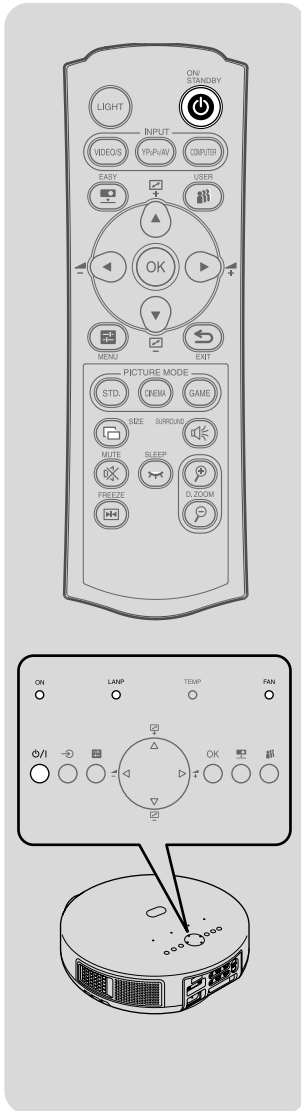

1 Press the ON/STANDBY button.

Remote control Control panel



The power is turned on, and three (ON, LAMP, and FAN) indicators come on in green. After a moment, the startup screen appears.

ON	LAMP	TEMP	FAN
●	●	○	●
(Green) Lit	(Green) Lit		(Green) Lit

! WARNING

- Do not look into the lens during operation. Doing so could damage your vision.
- Families with children should be particularly careful.

! CAUTION

- Do not block the air intake or exhaust. Doing so could cause a fire due to internal overheating.
- Do not place your hands, face, or other objects near the air exhaust. Doing so could cause burns or deform, discolor, or break the object.

Notes

- The startup screen will disappear after a moment. You can dismiss the startup screen before this by performing any operation.
- After the startup screen disappears, the language menu is displayed when you use the projector for the first time after purchase. (See [p.20.](#))
- Turning the power on starts the cooling fan running with operating sound.

Safety lock

You can prevent the projector's power from being turned on accidentally. Set the safety lock switch on the bottom of the main unit to ON.



In standby mode with the safety lock switch set to ON, the ON indicator lights in orange and in green alternately.

Once you have set the safety lock switch to ON, you have to hold down the ON/STANDBY button for at least two seconds to turn on the power of the projector. Other operations are the same.

Turning the power off

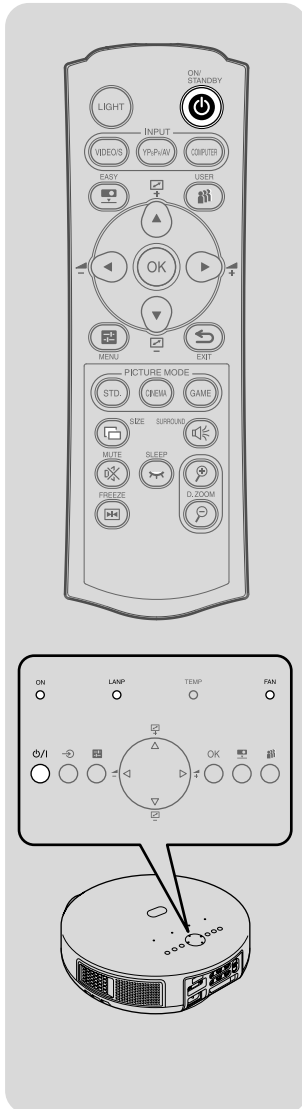

1 Press the ON/STANDBY button.

Remote control Control panel

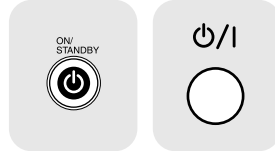

A message appears on the screen, confirming that you wish to shut off the power. This message will disappear after a moment. (This operation is no longer valid after the message disappears.)

2 Press the ON/STANDBY button again.

Remote control Control panel

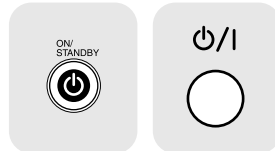

The screen is turned off, but the internal cooling fan continues to operate for a short while. Then, the projector goes into standby mode.

Cooling in progress

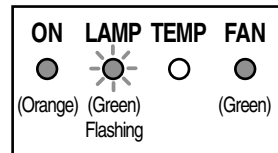

During cooling, the LAMP indicator flashes. In this state, the power cannot be turned back on. In addition, unplugging the power cord in this state will shorten the life of the lamp.

Cooling completed

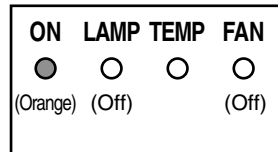

The LAMP and FAN indicators go off, and the projector goes into standby mode.

Note

- The projector consumes about 1 W (AC 100 - 120 V) or 3 W (AC 220 - 240 V) of power in standby. You should unplug the power cord if you will not use the projector for an extended period.

PRECAUTIONS

- Before unplugging the power cord, make sure that the LAMP indicator is off. Unplugging the power cord to cut off the power while the projector is running or being cooled will shorten the life of the lamp. However, please unplug the power cord if the projector locks up or acts abnormally.
- If the power cord was unplugged before cooling was completed, give the lamp sufficient time to cool down before plugging it back in. If the lamp overheats, it may fail to light, and its lifetime will be shortened.
- Before turning the power off, turn down the volume if possible.

Projecting

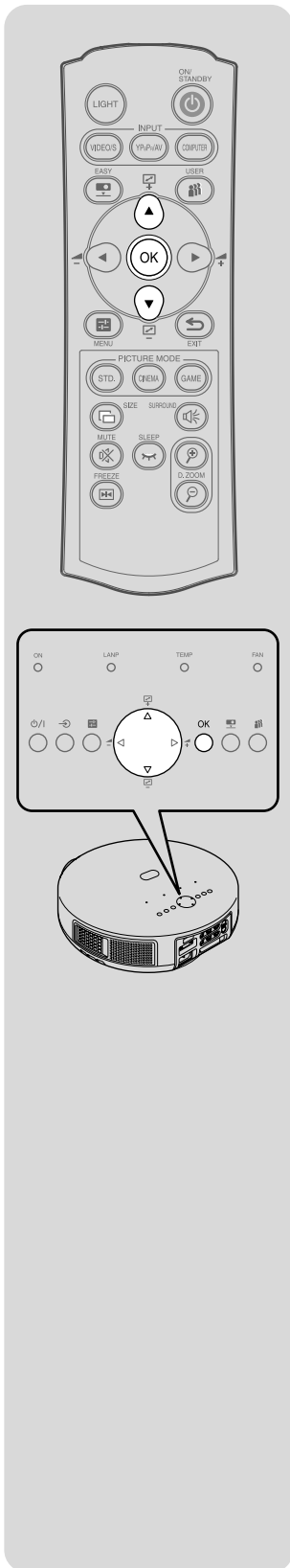

1 Turn on the power.

Turn on the power by following the instructions in "Turning the power on" (see ➡ p.18).

2 Adjust the projection angle.

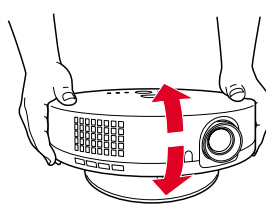

Adjust the angle of the main unit as you like.

- The angle can be adjusted within a range of approximately $\pm 10^\circ$ in a horizontal position.

3 Adjust the screen focus.

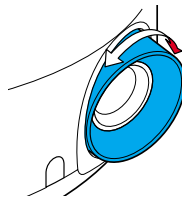

Adjust the focus using the focusing ring.

4 Select the language (when using the unit for the first time).

English	English
Français	French
Deutsch	German
Italiano	Italian
Español	Spanish
Português	Portuguese
日本語	Japanese

When the projector is used for the first time after purchase, the menu for selecting the language for on-screen messages and menu items is displayed in English.

Remote control Control panel

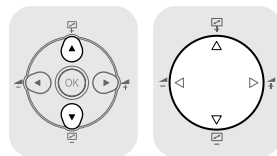

① Use the ▲ and ▼ buttons to select the desired language.

Remote control Control panel

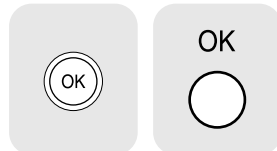

② Press the OK button to accept the language setting.

The message for setup confirmation is displayed in a selected language.

- The language can also be set via the "Language" option in the "Default setting" menu (see ➡ p.35).
- This owner's manual assumes that English has been selected.

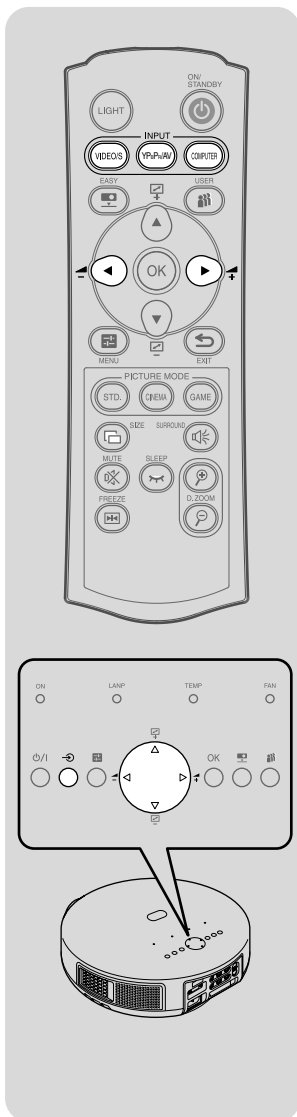

5 Place the connected device in operating status.

Turn on the connected device such as a video device.

6 Select the connected input.

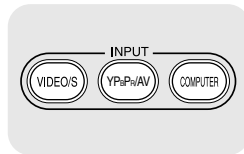

(Using the remote control)
Press an INPUT button (VIDEO/S, YPBPR/AV, or COMPUTER) to select the input.
 The picture from the selected input will be projected.

- Pressing the VIDEO/S button switches the projected picture between the VIDEO and S-VIDEO inputs.
- Pressing the YPBPR/AV button switches the projected picture between the Y/PB/PR and AV inputs. (This function is available only for the TLP-ET1B and TLP-ET1E.)

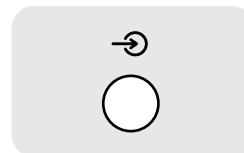

(Using the control panel)
Press the INPUT button on the main unit to select the input.
 Pressing the INPUT button switches the inputs as shown below.



- "AV" is available only for the TLP-ET1B and TLP-ET1E.

7 Adjust the volume with the ◀ (⏪) and ▶ (⏩) buttons.

Remote control Control panel

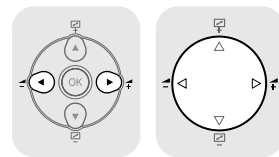

The speaker volume can be adjusted when an audio signal is being input.

Notes

- Note that because of the lamp characteristics, the brightness of the lamp may fluctuate slightly.
- A lamp is a consumable supply. If the lamp is used for an extended period, images will appear dark, and the lamp could burn out. This is characteristic of a lamp, and is not a malfunction.
- Although this projector supports a wide range of RGB signals (see p.48), any resolution signals that exceed the number of pixels of the LCD panel of this projector will enlarge or compress the pictures, causing lack of some information or affecting image quality.
- With some models of computer having LCD displays or the like, displaying images simultaneously on the projector and the monitor's display may cause the images to be shown improperly. If this happens, turn off the computer's LCD display. For information on how to turn off the LCD display, see the owner's manual of your computer.
- If a signal not supported by the projector is input, the ? icon will appear.
- If a no signal is being input from the connected device, the OFF icon will appear. The screen color will also change to blue and the TOSHIBA logo will appear.
- If no signal is being input for more than 10 minutes, the power will be automatically turned off and the unit will be placed in the standby state.
- If an unavailable operation button is pressed, the ✖ icon will appear.
- The audio input to the Audio terminals is played regardless of the input source. (When the AV input is selected, however, AV IN audio is played.)

Easy setup using the EASY button

You can use the EASY button to configure frequently used adjustments and settings. For any settings (adjustments) other than the settings (adjustments) described in this section, see “Using the menus” (➔ p.30) to make the settings (adjustments) as required.

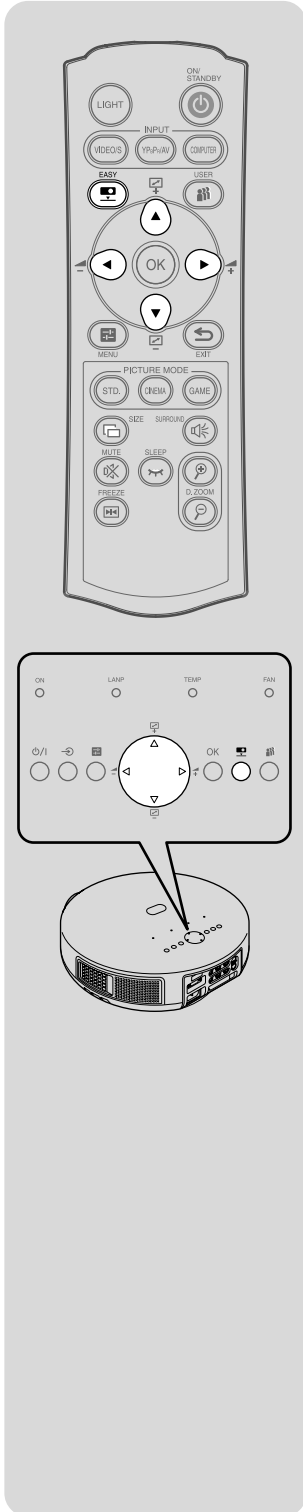

1

Press the EASY button.

Remote control Control panel

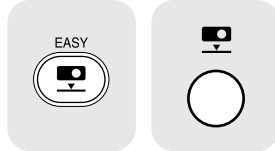

The “Easy setting” menu appears.

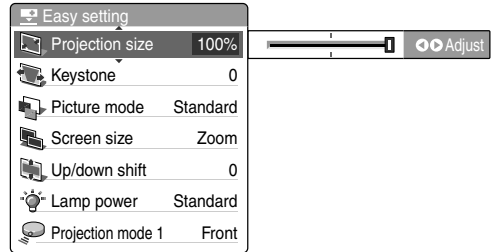

2

Use the ▲ and ▼ buttons to select the menu item you want to set or adjust.

Remote control Control panel

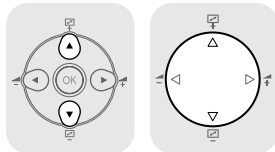

The selected item can now be set or adjusted.

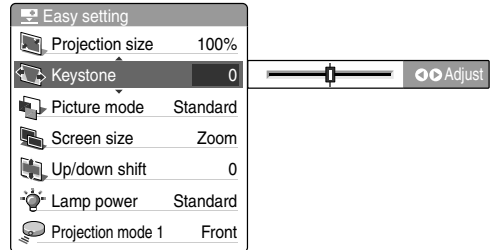

3

Use the ◀ and ▶ buttons to set or adjust the selected item.

Remote control Control panel

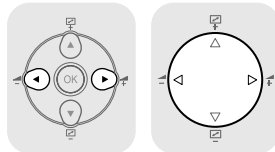

Set or adjust the selected item by referring to the table on ➔ p.23.

Some items need to be set with ▲ and ▼ buttons after pressing OK button.

4





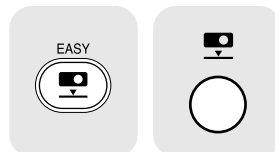

Repeat steps 2 and 3 above to complete settings or adjustments, then press the EASY button.

Remote control Control panel



The menu disappears.

- You can also dismiss the menu by pressing the EXIT button on the remote control.

Item	Description
 Projection size	Change the picture area size on the screen. Use ◀ to decrease the projection size or ▶ to increase it. See ➡ p.24 for details.
 Keystone	Correct the keystone (trapezoid) distortion of the screen. (For keystone distortion, see “Correction of keystone distortion” described below.) Use ◀ to shrink the lower part or ▶ to shrink the upper part.
 Picture mode	Switch to the picture mode suitable for movie or game screens. Press OK button first, and then set the item with ▲ and ▼ buttons. Standard/Cinema/Game
 Screen size	Switch the screen size. Press OK button first, and then set the item with ▲ and ▼ buttons. Full/Theater wide/4:3/Zoom See ➡ p.25 for details.
 Up/down shift	Scroll the screen up or down, for example, when subtitles are outside the picture area. (Adjustable only when the screen size is “Zoom”). Down ◀ ▶ Up
 Lamp power	Lower lamp power to decrease the cooling fan noise. Standard/Low Setting lamp power “Low” makes the screen a little darker but makes the cooling fan noise quieter.
 Projection mode 1	Select whether the placement style is front or rear projection. Front/Rear

Notes

- “Projection size” can also be adjusted by using ▲ (◻) and ▼ (◻) buttons, on the remote control or main unit. (See ➡ p.24.)
- Decreasing the projection size may affect image quality slightly. (It does not change the menu size.)
- “Picture mode” can also be set via the PICTURE MODE button on the remote control or the “Picture adjustment” menu. (See ➡ p.27, 32.)
- “Screen size” can also be set via the SIZE button on the remote control or the “Default setting” menu. (See ➡ p.25, 35.)
- “Keystone”, “Up/down shift”, “Lamp power”, and “Projection mode 1” can also be adjusted via the “Default setting” menu. (See ➡ p.35.)
- The items set and adjusted on the “Easy setting” menu are saved when the power is turned off with the ON/STANDBY button. They are not saved if power is disconnected by unplugging the power cord or by a power failure.

● Correction of keystone distortion

When the tilt stand (see ➡ p.20) is used to change the projection angle, the picture will undergo keystone (trapezoid) distortion.

The projector is capable of correcting this keystone distortion.

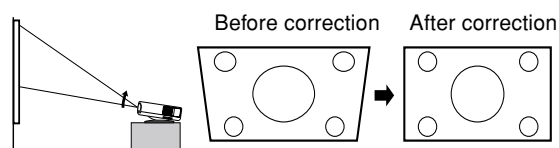

- Depending on the amount of keystone adjustment and the content of images, some information may be lost or the picture quality may suffer. Keystone adjustment will not change the shape of the menus.

Changing the projection size

You can change the projection size (picture area size on the screen).

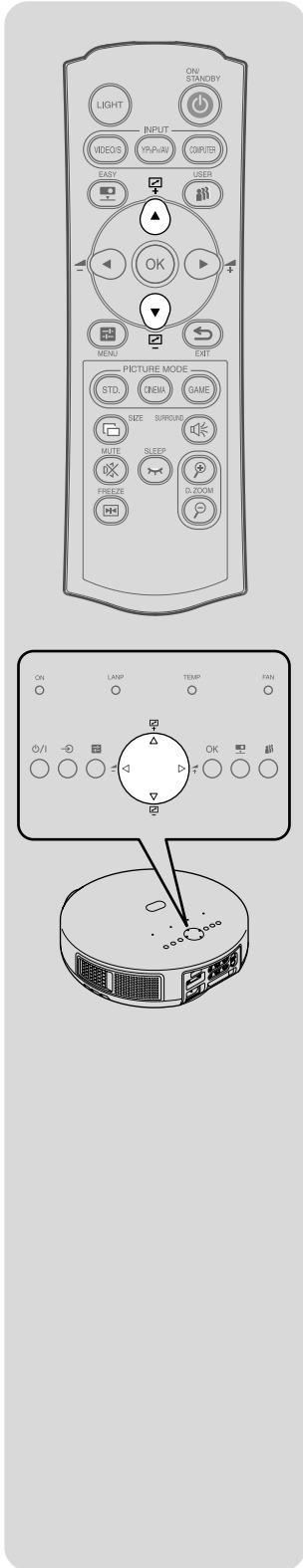

1 Press the button.

Remote control Control panel

The adjustment bar is displayed.

Pressing the button decreases the projection size.

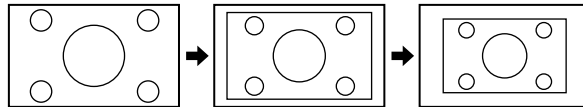
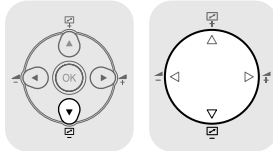

2 Press the button.

Remote control Control panel

The adjustment bar is displayed.

Pressing the button increases the projection size.

You cannot make the image larger than its original size.

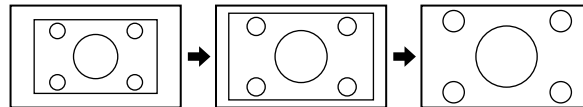
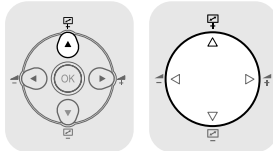

Notes

- The “Projection size” can also be adjusted via the “Easy setting” menu. (See p.22.)
- Decreasing the projection size may degrade the images more or less.

Changing the screen size

The projection screen of this projector is 16:9, though the screen size can be changed depending on the input signal.

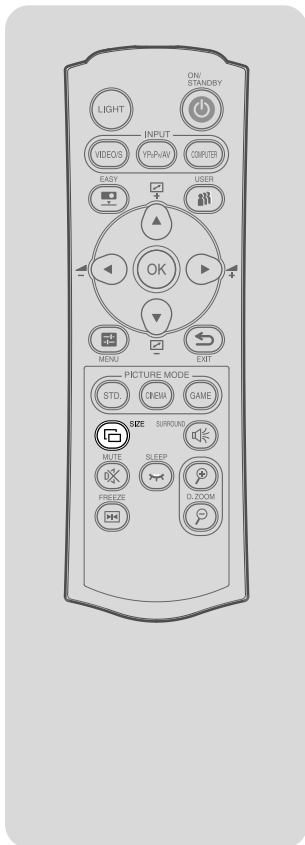

1 Press the SIZE button on the remote control.



Pressing the SIZE button for the first time displays the current screen size. Pressing the SIZE button while the current screen size is displayed cycles the screen size through the following options:

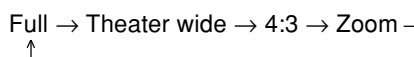

- Full** : This mode is best for squeeze-signal video images.
- Theater wide** : This mode is best for 4:3-signal video images on the wide screen.
- 4:3** : This mode is best for 4:3-signal video images on the 4:3-size screen.
- Zoom** : This mode is best for video images of letter-box or cinema signals.

Input signal	Projection screen	
4:3 signal 	Full ↑ Zoom 	Theater wide (O) ↓ 4:3 signal
Squeeze signal 	Full (O) ↑ Zoom 	Theater wide ↓ 4:3 signal
Letter box signal 	Full ↑ Zoom (O) 	Theater wide ↓ 4:3
Cinema signal 	Full ↑ Zoom (O) 	Theater wide ↓ 4:3

(O): Optimum screen size

Notes

- The screen size cannot be changed when the 16:9 signal is input.
- You cannot select "Theater wide" and "Zoom" when the input is COMPUTER.
- An adjustment bar of "Up/down shift" is displayed in "Zoom" mode and you can make the adjustment (See p. 23, 35.)
- If you use this function on commercial video software or on a broadcast or cable broadcast except for the purpose of your private viewing and listening, it may infringe the copyright protected by the copyright laws.

Cutting off the sound/Pausing the picture

Cutting off the sound temporarily (Mute)

You can turn off the projector's sound temporarily.



1 Press the MUTE button on the remote control.



The sound are cut off.
Pressing the MUTE button again cancels the Mute function and releases the sound.

Notes

- The  icon will appear while Mute is in effect.
- Operating any other function cancels the muting.
- It can also be canceled by pressing the EXIT button on the remote control.

Cutting off both the picture and sound temporarily (Sleep)

You can turn off both the projector's picture and sound temporarily.



1 Press the SLEEP button on the remote control.



The picture and sound are cut off.
Pressing the SLEEP button again cancels the Sleep function and releases the picture and sound.

Notes

- The  icon will appear while Sleep is in effect.
- Operating any other function cancels the sleeping.
- It can also be canceled by pressing the EXIT button on the remote control.

Pausing the picture (Freeze)

You can pause the picture being projected.



1 Press the FREEZE button on the remote control.



The picture pauses.
Pressing the FREEZE button again cancels the Freeze function.

Notes

- The  icon will appear while Freeze is in effect.
- The Zoom function can be used on a frozen image to enlarge it. The freeze is canceled by performing any other operation or by pressing the EXIT button on the remote control.
- Even if an image is frozen on the projector, the pictures are running on the video or other device. Audio continues to be output as well.
- If you use this function on commercial video software or on a broadcast or cable broadcast except for the purpose of your private viewing and listening, it may infringe the copyright protected by the copyright laws.

Switching the picture and sound

Setting the picture mode

You can switch the picture mode suitable for the movie or game screen.

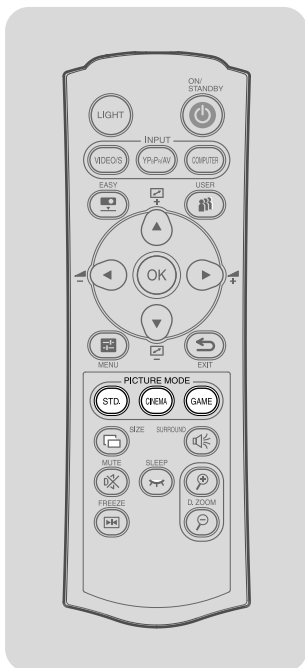

1 Press a **PICTURE MODE** button (**STD./CINEMA/ GAME**) on the remote control.

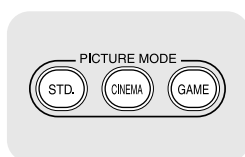

The projector will switch to the selected picture mode.

- STD. : Standard picture mode
- CINEMA : Suitable for watching movies
- GAME : Suitable for game screens

- Select the desired picture mode.

Switching to surround sound

Surround sound reproduces deep and expanded atmospheres through natural, realistic sensations.

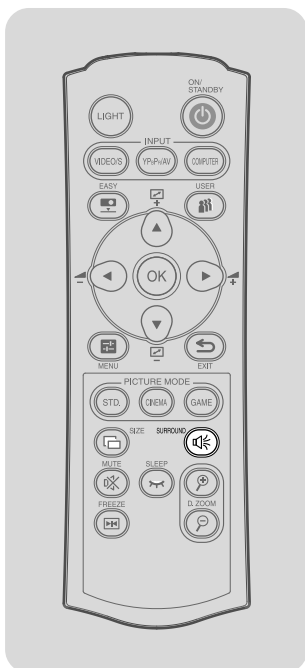

1 Press the **SURROUND** button on the remote control.



Pressing the SURROUND button for the first time displays the current surround mode. Pressing the SURROUND button while the current surround mode is displayed cycles the sound through the following options:



- OFF** : Surround (Off)
- : Surround (Soft)
- : Surround (Hard)
- : Turns a mono signal into quasi-stereo.

Notes

- Surround sound can also be set via the “Audio adjustment” menu (see ➡ p.34).
- Surround sound effect depends on each input source.
- Selecting with a stereo source may lose its true-stereo sensation.

Enlarging the picture (Zoom)

You can enlarge (zoom in) the image being projected.

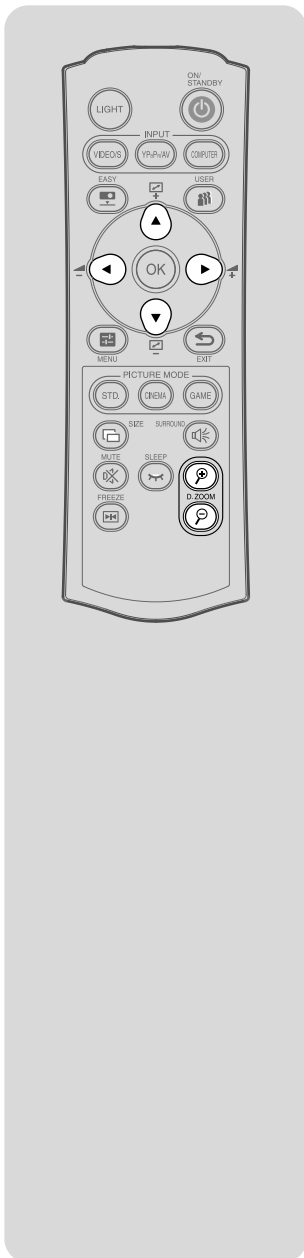

1 Press the **D.ZOOM**  button on the remote control.

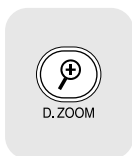

Pressing the D.ZOOM  button increases the zoom magnification.

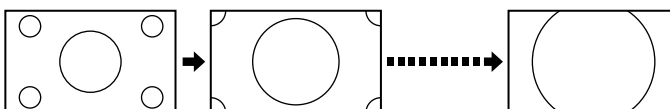

2 To decrease the zoom magnification, press the **D.ZOOM**  button on the remote control.

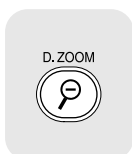

Pressing the D.ZOOM  button decreases the zoom magnification. (The image cannot be shrunk to less than its original size.)

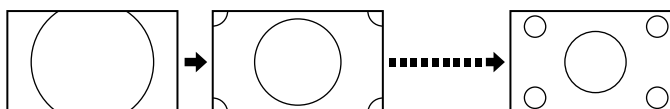

3 Use the , , , and  buttons to move the enlarged area.

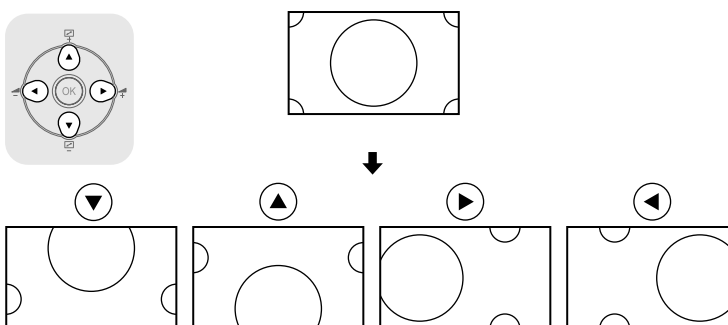

 **Notes**

- The  icon will appear while Zoom is in effect.
- An enlarged image can be frozen using the FREEZE button. The Zoom function on the frozen image can also be used.
- Since the enlargement is performed by digital processing, enlarging will cause the image to appear jagged.
- Rarely, the picture could become garbled while the enlarged area is being moved.
- Operations other than Freeze will cancel the zooming.
- It can also be canceled by pressing the EXIT button on the remote control.
- If you use this function on commercial video software or on a broadcast or cable broadcast except for the purpose of your private viewing and listening, it may infringe the copyright protected by the copyright laws.

Calling up a user profile

You can easily switch the projector to the settings saved on the “User memory” menu (see ➔ p.37).

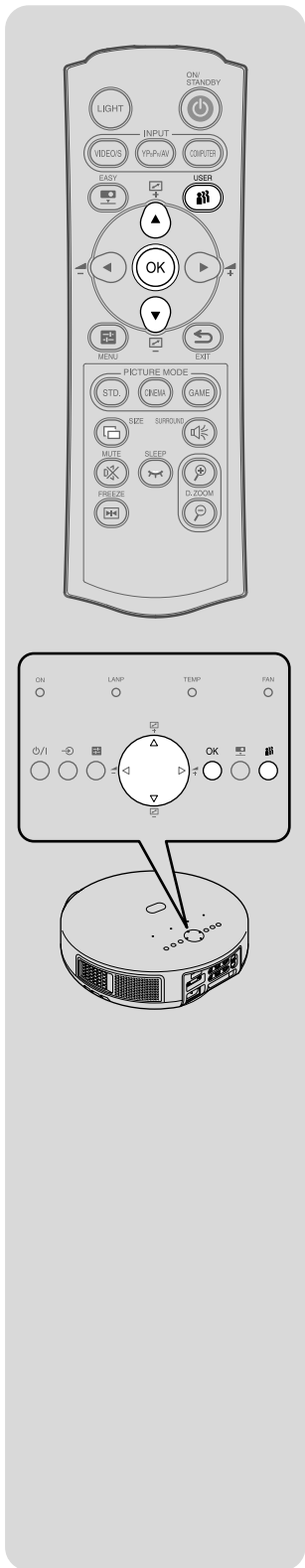

1 Press the USER button.

Remote control Control panel

The “User memory call” menu will appear.

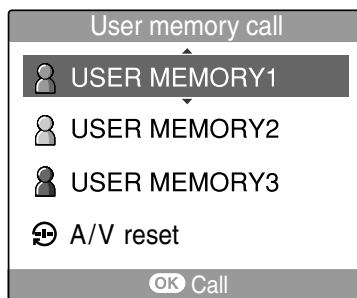
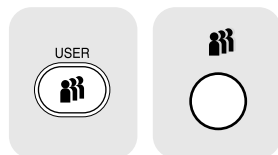

Pressing the USER button again will dismiss the “User memory call” menu. Pressing the EXIT button on the remote control will also dismiss the “User memory call” menu.

2 Use the ▲ and ▼ buttons to select the settings saved (as a user profile) in user memory, then press the OK button.

Remote control Control panel

The projector is switched to the selected user memory settings. Selecting “A/V reset” resets only the items in the “Picture adjustment” and “Audio adjustment” menus to their default settings.

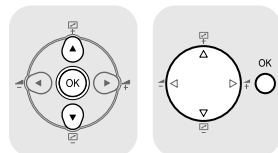

Using the menus

How to use the menus

You can call up on-screen menus, and conduct a number of adjustments and settings using the operation buttons on the remote control and on the main unit's control panel.

For details on each adjustment and setting item, see the corresponding page.

Menus shown below are only for operation instructions and might be different from the actual display.

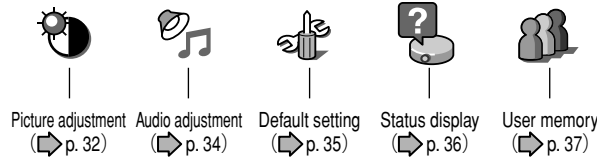

1 Press the MENU button.

The menu screen will be displayed.

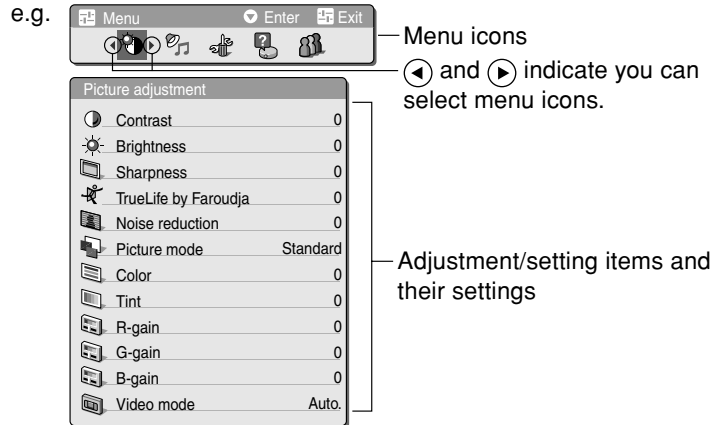

2 Use the ◀ and ▶ buttons to select a desired menu icon, then press the ▼ button.

The cursor moves to the corresponding adjustment/setting item.

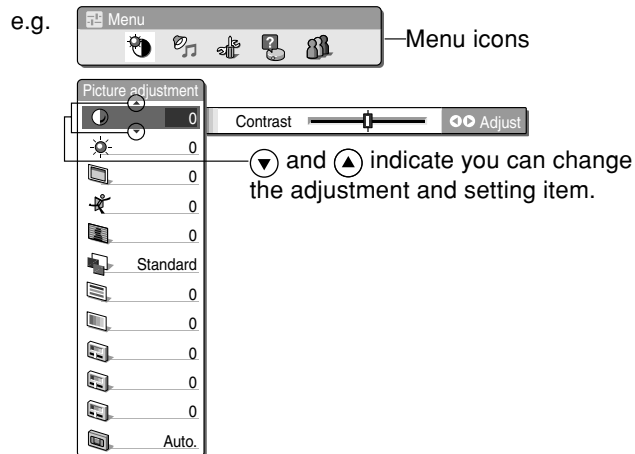

3 Use the **▲** and **▼** buttons to select a desired adjustment or setting item.

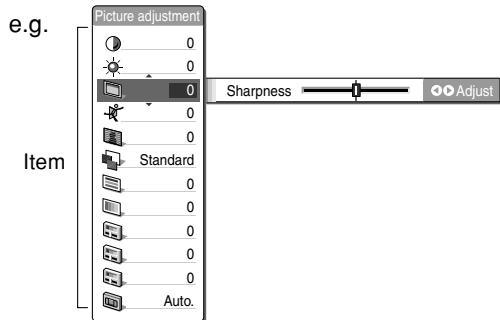

(When an adjustment item is selected)

4 Use the **◀** and **▶** buttons to adjust the selected item.

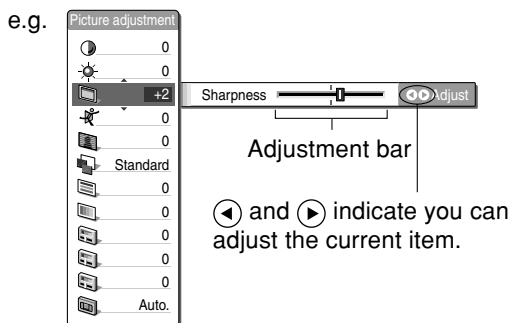

(When a setting item is selected: 1)

4 Use the **◀** and **▶** buttons to set the selected item.

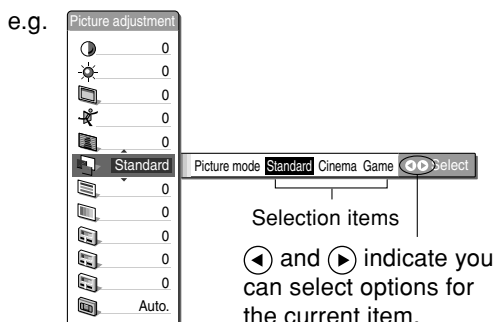

Notes

- Pressing the MENU button with a menu screen displayed returns you to the previous menu screen.
- Pressing the EXIT button on the remote control dismisses the menu screen.
- The items adjusted and set with these menus are saved when the power is turned off with the ON/STANDBY button. They are not saved (except the user memory and lamp time settings) if power is disconnected by unplugging the power cord or by a power failure.

(When a setting item is selected: 2)

4 Press the OK button if an adjustment bar or selection items did not displayed on the Step 3. A selection list will appear.

5 Use the **▲** and **▼** buttons to set the item.

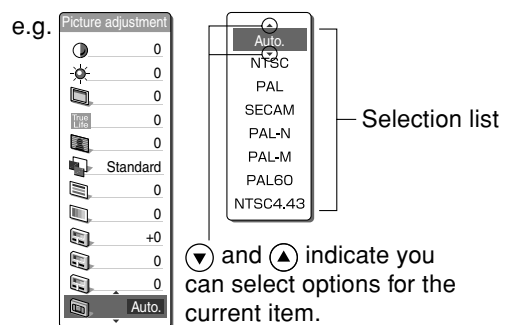

6 Press the OK button.

The selection list will disappear.

(When an execution item is selected)

4 Press the OK button if an adjustment bar or selection items did not displayed on the Step 3.

A confirmation dialog box will appear, asking you whether to execute the item.

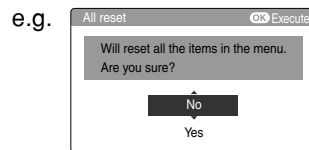

5 To execute the item, select "Yes" using the **▲** and **▼** buttons, then press the OK button.

Operations

Using the menus (Continued)

Picture adjustment menu

Use this menu to adjust image-related items.

e.g.

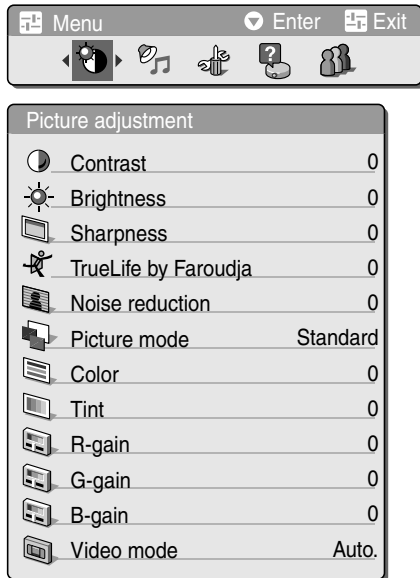

1 Press the MENU button.

2 Use the ◀ and ▶ buttons to select the picture adjustment menu icon [🔍], then press the ▼ button.



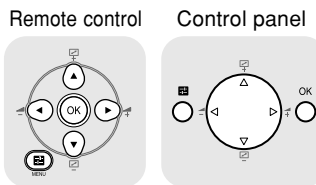







3 Use the ▲ and ▼ buttons to select an item you want to adjust, then adjust it according to the table shown below.



Item	Description	Video	S-video	Y/Pb/Pr	AV	Computer
🌑 Contrast	Adjust picture contrast. Lower ◀ ▶ Higher	Yes	Yes	Yes	Yes	Yes
☀️ Brightness	Adjust picture brightness. Darker ◀ ▶ Brighter	Yes	Yes	Yes	Yes	Yes
🖨️ Sharpness	Adjust picture sharpness. Softer ◀ ▶ Sharper	Yes	Yes	Yes	Yes	–
👤 TrueLife by Faroudja	Enhance uneven edges, for example, of skins without highlighting outlines. Lower ◀ ▶ Higher	Yes	Yes	Yes	Yes	–
📺 Noise reduction	Adjust noise reduction on the screen. Lower ◀ ▶ Higher	Yes	Yes	Yes*1	Yes	–
🖨️ Picture mode	Switch the picture mode using ◀ and ▶. Standard/Cinema/Game	Yes	Yes	Yes	Yes	–
📺 Color	Adjust picture color density. Lighter ◀ ▶ Deeper	Yes	Yes	Yes	Yes	–
📺 Tint	Adjust picture tint (hue). Reddish ◀ ▶ Greenish	Yes*2	Yes*2	–	Yes	–
📺 R-gain	Adjust the base level of red in pictures. Lower ◀ ▶ Higher	Yes	Yes	Yes	Yes	Yes
📺 G-gain	Adjust the base level of green in pictures. Lower ◀ ▶ Higher	Yes	Yes	Yes	Yes	Yes
📺 B-gain	Adjust the base level of blue in pictures. Lower ◀ ▶ Higher	Yes	Yes	Yes	Yes	Yes

*1 "Noise reduction" can be adjusted only when the signal formats are 480i and 576i.

*2 "Tint" can be adjusted only when the video modes are NTSC and NTSC4.43.

Item	Description	Video	S-video	Y/Pb/Pr	AV	Computer
 Auto setting	Adjust items, such as the sampling phase, depending on the type of input signal. Press the OK button.	–	–	–	–	Yes
 Phase	Adjust with ◀ and ▶ to minimize flicker.	–	–	Yes	–	Yes
 Frequency	Adjust with ◀ and ▶ to minimize periodic patterns and flickering when many vertical lines appear on the screen.	–	–	–	–	Yes
 H-position	Adjust the horizontal position of the picture screen. Move left ◀ ▶ Move right	–	–	–	–	Yes
 V-position	Adjust the vertical position of the picture screen. Move up ◀ ▶ Move down	–	–	–	–	Yes
 Clamp	1) Press the OK button. 2) Use ▲ or ▼ to select Clamp 1 or 2.  Clamp 1: Adjust the position of the clamp pulse. Down ◀ ▶ Up  Clamp 2: Adjust the width of the clamp pulse. Shorter ◀ ▶ Longer	–	–	–	–	Yes
 Signal format	Set the Y/Pb/Pr signal DTV format. 1) Press the OK button. 2) Select one from the displayed list with ▲ and ▼, then press the OK button. Auto: Automatically identifies the type of input signal. If this fails, select one from the following: 480i(525i)@60/480p(525p)@60/ 576i(625i)@50/576p(625p)@50/ 720p(750p)@60/720p(750p)@50/ 1080i(1125i)@60/1152i(1250i)@50/ 1035i(1125i)@60/1080i(1125i)@50	–	–	Yes	–	–
 Video mode	Set the VIDEO and S-VIDEO color system. 1) Press the OK button. 2) Select one from the displayed list with ▲ and ▼, then press the OK button. Auto: Automatically identifies the type of input signal. If this fails, select one from the following: NTSC/PAL/SECAM/PAL-N/PAL-M/PAL60/NTSC4.43	Yes	Yes	–	Yes	–

Notes

- Items can be adjusted/set (marked with “Yes”) or cannot (marked with “–”) depending on each type of input.
- Pressing the EXIT button on the remote control dismisses the menu screen.

Operations

Using the menus (Continued)

Audio adjustment menu

Use this menu to adjust audio-related items.

e.g.

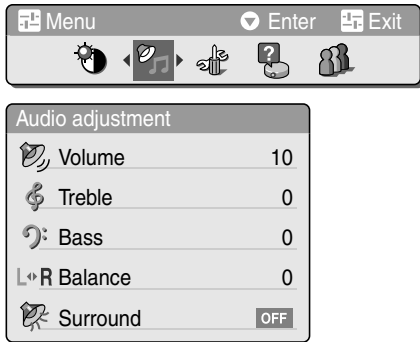

1 Press the MENU button.

2 Use the ◀ and ▶ buttons to select the audio adjustment menu icon [🎵], then press the ▼ button.

3 Use the ▲ and ▼ buttons to select an item you want to adjust, then adjust it according to the table shown below.

Remote control Control panel

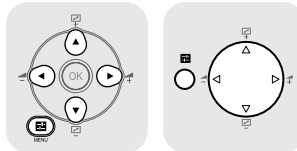

Item	Description
🔊 Volume	Adjust the volume of sound. Down ◀ ▶ Up
🎵 Treble	Adjust the higher frequency range of audio output. Weak ◀ ▶ Strong
🎵 Bass	Adjust the lower frequency range of audio output. Weak ◀ ▶ Strong
L+R Balance	Adjust the balance in volume level between the left and right speakers. Increase left ◀ ▶ Increase right
🎧 Surround	Select a surround sound effect mode with ◀ and ▶. <div style="text-align: center;"> OFF / 🔊 / 🔊 / 🔊 </div> <ul style="list-style-type: none"> OFF : Surround (Off) 🔊 : Surround (Soft) 🔊 : Surround (Hard) 🔊 : Turns a mono signal into quasi-stereo.

Notes

- Pressing the EXIT button on the remote control dismisses the menu screen.
- On rare occasions, turning up the volume or bass may cause the projected screen to flutter, depending on the input audio signal level. If this is the case, turn it down.

Default setting menu

Use this menu to make settings such as the placement style (projection mode).

e.g.

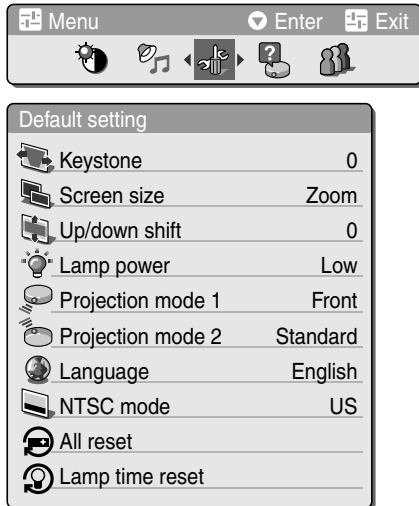

1 Press the MENU button.

2 Use the ◀ and ▶ buttons to select the default setting menu icon [MENU], then press the ▼ button.

3 Use the ▲ and ▼ buttons to select an item you want to set, then set it according to the table shown below.

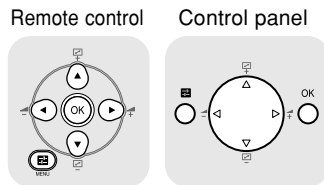

Item	Description
Keystone	Correct the keystone (trapezoid) distortion of the screen. Shrinking lower part ◀ ▶ Shrinking upper part
Screen size	Set the screen size mode. 1) Press the OK button. 2) Select one from the displayed list with ▲ and ▼, then press the OK button. Full/Theater wide/4:3/Zoom (“Theater wide” and “Zoom” cannot be selected when the input is COMPUTER.) This item can also be set with the SIZE button on the remote control. (See ⇨ p.25.)
Up/down shift	Scroll the screen up or down, for example, when subtitles are outside the picture area. (Adjustable only when the screen size is “Zoom”) Down ◀ ▶ Up
Lamp power	Select lamp power with ◀ and ▶. Standard/Low
Projection mode 1	Select projection mode 1 with ◀ and ▶, according to the projector's placement style. Front/Rear
Projection mode 2	Select projection mode 2 with ◀ and ▶, according to the projector's placement style. Standard (floor-mounted)/Ceiling
Language	Select the language for on-screen menus and messages. 1) Press the OK button. 2) Select one from the displayed list with ▲ and ▼, then press the OK button. English/Français/Deutsch/Italiano/Español/Português/日本語
NTSC mode	Set with ◀ and ▶. US : NTSC (US) mode JAPAN: NTSC (JAPAN) mode
All reset	Reset all of the adjustment and setting items to the defaults. 1) Press the OK button. 2) In the dialog box displayed, use ▲ or ▼ to select whether to execute this function, then press the OK button.
Lamp time reset	Reset the lamp timer. (See ⇨ p.44)

Note

- Pressing the EXIT button on the remote control dismisses the menu screen.

Operations

Using the menus (Continued)

Status display menu

This menu displays information about the input signal, lamp use time, etc.

e.g.



Status display	
Input	COMPUTER
Mode name	XGA
H-resolution	1024
V-resolution	768
H-frequency	000,00Hz
V-frequency	000,00Hz
Sync	N/N
Lamp time	0000H
Version	0000-0000

1 Press the MENU button.

2 Use the ◀ and ▶ buttons to select the Status display menu icon [?].

The "Status display" menu will appear.

Remote control Control panel

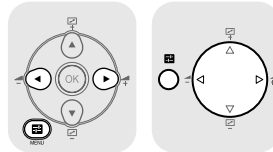

Item	Description	Video	S-video	Y/Pb/Pr	AV	Computer
Input	Displays the input source name.	Yes	Yes	Yes	Yes	Yes
Mode name	Displays the RGB signal mode name.*1	—	—	—	—	Yes
H-resolution	Displays the horizontal resolution (in dots).	—	—	—	—	Yes
V-resolution	Displays the vertical resolution (in dots).	—	—	—	—	Yes
H-frequency	Displays the horizontal sync frequency.	—	—	—	—	Yes
V-frequency	Displays the vertical sync frequency.*2	—	—	—	—	Yes
Sync	Displays the sync signal polarity.*3	—	—	—	—	Yes
Signal format	Displays the Y/Pb/Pr signal format.	—	—	Yes	—	—
Video mode	Displays the video signal color system.	Yes	Yes	—	Yes	—
Lamp time	Displays the total time of lamp use.*4	Yes	Yes	Yes	Yes	Yes
Version	Displays the firmware version.*5	Yes	Yes	Yes	Yes	Yes

*1 : The mode of supported RGB signals (➡ p.48) is shown.

*2 : Same as the refresh rate of the computer signal.

*3 : Sync signal polarity shown as P (positive) or N (negative) for "H/V".

*4 : Display "Lamp time" as a measure of when the lamp should be replaced. (Cannot be used as a counter of guaranteed lamp time.)

*5 : "Version" shows the version of the projector's internal control program. This version is referred for customer service, etc.

Notes

- Items can be displayed (marked with "Yes") or cannot (marked with "—") depending on each type of input.
- Pressing the EXIT button on the remote control dismisses the menu screen.

User memory menu

Use this menu to register up to three sets of adjustments and settings made on the menu screen as user profiles. You can call any of the user profiles later using the USER button. (See [p.29](#).)

1 Press the MENU button.

2 Use the ◀ or ▶ button to select the user memory menu icon [👤].

Remote control Control panel

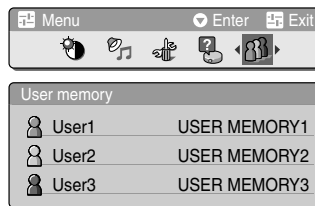
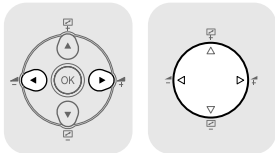

The user memory registration menu will appear.

3 Press the ▼ button.

Remote control Control panel

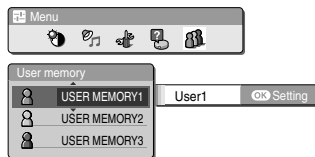
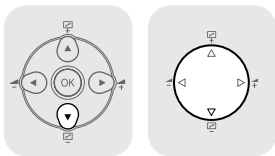

The user memory select menu will appear.

4 Use the ▲ or ▼ button to select the user memory number with which you want to register the current settings, then press the OK button.

Remote control Control panel

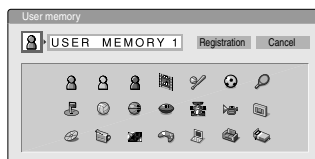
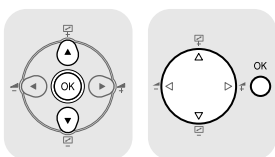

The icon select menu will appear.

5 Press the OK button, use the ▲, ▼, ◀, or ▶ button to select a desired icon, then press the OK button.

Remote control Control panel

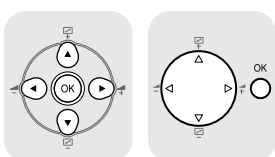

The cursor will move to the user memory registration icon.

(Continued)

Operations

Using the menus (Continued)

- 6** Press the button, move the cursor to the user memory registration name, then press the OK button.

Remote control Control panel

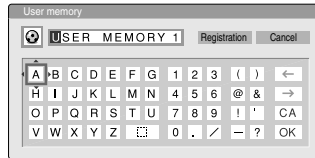
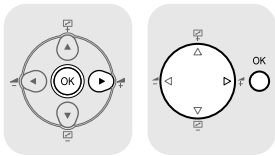

The user memory name input screen will appear.

- 7** Use the , , , and buttons to select each character you want to enter, then press the OK button.

Remote control Control panel

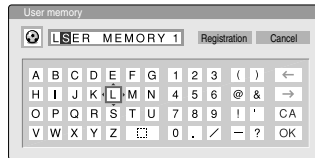
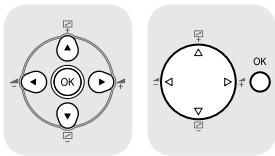

Press the OK button after selecting each character. To clear all the input characters, select "CA" and press the OK button.

- 8** When you finish entering characters, use the , , , and buttons to select "OK", then press the OK button.

Remote control Control panel

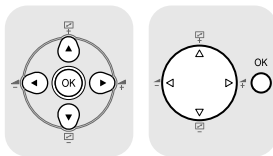

The cursor will be moved to the user memory registration name.

- 9** Use the button to select "Registration", then press the OK button.

Remote control Control panel

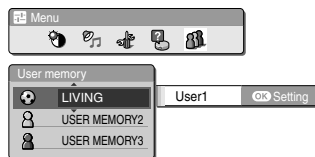
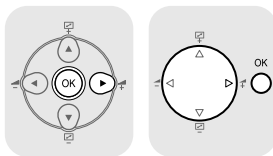

The current settings are registered in the selected user memory number.

To return to the screen of Step 3, select "Cancel" and press the OK button.

Notes

- To change a registered icon or user memory name, re-register it from the beginning.
- Pressing the EXIT button on the remote control will dismiss the menu screen.

Removing the tilt stand

Do not remove the tilt stand unless when you replace the lamp or mount the projector on a ceiling. Removing the tilt stand leaves the projector unstable and may block the air intake at the bottom. Usually, the projector must be used with the tilt stand.

PRECAUTIONS

- Before removing the tilt stand, be sure to turn off the power and unplug the power cord.

1 Place the unit upside down.

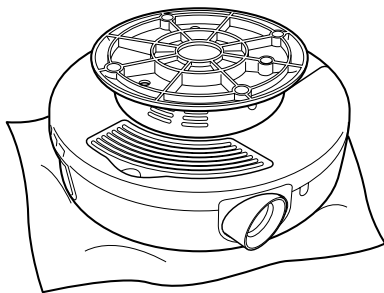

Turn the projector over and place it carefully. It is recommended to lay a soft cloth, such as a thick towel, under the unit to prevent it from shaking or getting scratched.

2 Loosen the three screws.

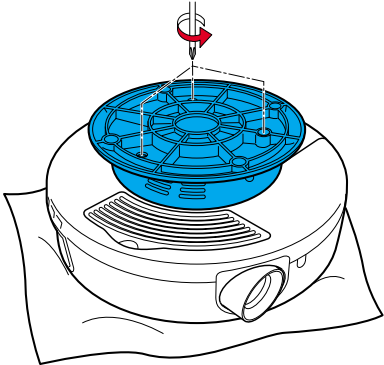

Position the tilt stand where you can see three screws in the centers of their respective screw holes. Loosen the screws by turning them counterclockwise several times.

3 Detach the tilt stand.

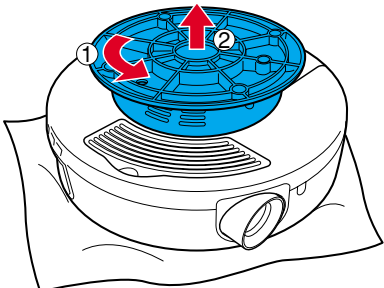

Hold the tilt stand with both hands, turn it counterclockwise, then lift it to remove.

To put the tilt stand back in place, take the above steps in reverse order. At this time, always make sure that the three screws have been tightened.

Air filter cleaning

The air filter prevents dust and debris from getting inside the projector. Never run the projector with the filter removed. The air filter should be cleaned regularly.

- The  icon message, “Check the air filter for dirt,” is displayed every 100 hours. (If the usage time exceeds 100 hours, this message is displayed for 30 seconds when the image is displayed for the first time after the power is turned on. The message will be dismissed with any operation.)
- Check out the filter and, if any debris is found, use the following procedure for cleaning.

WARNING

- Request cleaning and maintenance of a ceiling-mounted unit to your projector dealership.

1 Unplug the power cord.

2 Remove the air filter.

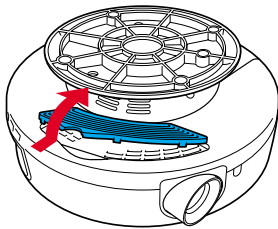

Pull out the air filter by taking the catch shown in the figure with your fingertips.
After turning the projector over, place it carefully. It is recommended to lay a soft cloth, such as a thick towel, under the unit to prevent it from shaking or getting scratched.

3 Clean the filter.

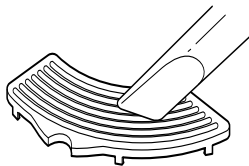

Carefully remove the dust and dirt from the air filter with a vacuum cleaner or the like.

4 Replace the air filter.

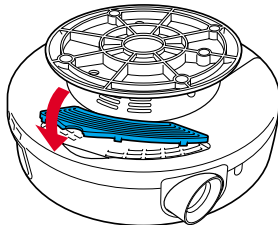

Notes

- Allowing dirt and dust to build up in the air filter will worsen the air circulation inside the projector, causing the internal temperature to rise, the projector to stop working or malfunction.
- Insert the air filter all the way in. Leaving gaps will allow dust and dirt to get inside the projector again.
- If the air filter is torn, consult with your dealer about replacing it with a new one. Continuing to use a ripped filter will allow dust and dirt to get inside the projector.

Lens and main unit cleaning

⚠ WARNING

- Request cleaning and maintenance of a ceiling-mounted unit to your projector dealership.

Lens cleaning

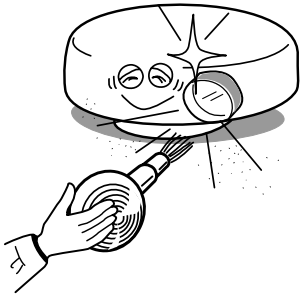

- Clean the lens with a commercially available blower and/or lens cleaner.
- The lens is easily scratched, so do not rub it with hard objects, or strike it.

Main unit cleaning

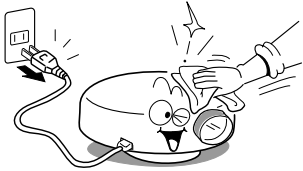

- Clean the main unit after unplugging the power cord.
- Wipe dirt off the main unit gently with a soft cloth.
- If the soiling is severe, dip the cloth in a neutral detergent diluted in water, wring well, and gently wipe off the dirt, then finish up by wiping with a dry cloth.

Replacing air intake and exhaust fans, and air filter

To maintain the performance, it is recommended that these should be replaced about every two or three years. Consult with your dealer for details.

Lamp replacement

A lamp is a consumable supply. If the lamp is used for an extended period, images will appear dark, and the lamp could burn out. This is a characteristic of a lamp, and is not a malfunction. (The lifetime of the lamp depends on conditions of use.) If this happens, replace it with a new one.

WARNING

- If the projector is mounted on a ceiling, request lamp replacement to your projector dealership.
- When replacing, always use dedicated lamp “TLPLET1” (sold separately).

CAUTION

- If you have been using the projector, the lamp will be very hot, and may cause burn injuries. Wait for the lamp to cool (for longer than one hour) before replacing it.
- If the lamp should break, please handle with care to avoid injury due to broken pieces (see  p.8) and contact your dealer for repair service.

Notes

- “Lamp time” in the “Status display” menu indicates the time of lamp use (as a rough guide).
- When “Standard” is set for the lamp power mode in the “Default setting” menu, replace the lamp after 2,000 hours of use as a guide. Using the unit with the “Low” lamp power mode extends the lifetime of the lamp.
- The lamp may stop lighting before the Lamp time reaches the hours as a guide or before a replacement message appears.

● Lamp replacement messages

- This unit displays lamp replacement messages at appropriate timings depending on the total time of lamp usage in the “Standard” or “Low” lamp power mode.
- The message, “Lamp life is approaching the end. Replace the lamp in earlier time,” starts appearing whenever you turn on the power from 100 hours before the replacement deadline. The message will be dismissed either after 30 seconds or with any operation.
- Once the lamp has reached the replacement deadline, the message, “Lamp life has ended. Replace the lamp immediately,” appears whenever you turn on the power. The message will be dismissed with any operation. The power is turned off automatically about seven minutes after the message appears (the LAMP indicator remains on in orange during that period).

1 Unplug the power cord.

2 Wait until the lamp is sufficiently cooled.

Wait for at least one hour.

3 Remove the tilt stand.

Follow the instructions in “Removing the tilt stand” (see  p.39) to remove the tilt stand.

4 Remove the lamp cover.

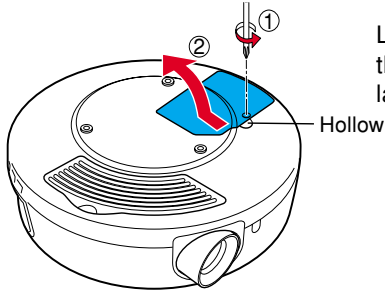

Loosen the screw, put your fingers on the hollow, then pull up to the direction of the arrow as shown in the figure to remove the lamp cover.

5 Pull out the lamp.

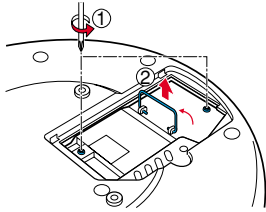

Loosen the two lamp locking screws, and pull up the handle to remove the lamp.

6 Mount the new lamp.

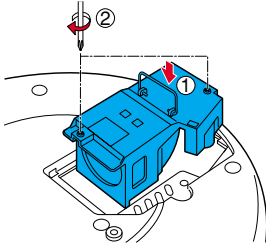

Align the orientation, press down the new lamp until it reaches to the bottom, and lock it in place using the two lamp locking screws.

7 Replace the lamp cover.

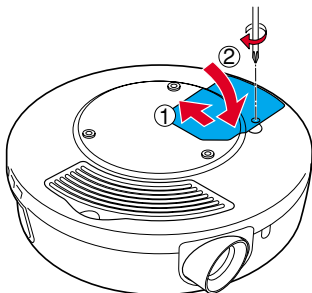

Align the lamp cover, and press it in, then tighten the screws loosened in Step 4 until the lamp cover is no longer loose.

8 Replace the tilt stand.

Put back the tilt stand using the reverse procedure to remove it.

(Continued)

9 Reset the lamp timer.

- ① **Turn on the power of this unit.**
The startup screen appears, followed by the replacement message screen.
- ② **Press the MENU button.**
The menu screen appears.
- ③ **Select “Lamp time reset” in the “Default setting” menu and press the OK button.**
- ④ **Select “Yes” on the dialog screen, then press the OK button.**
The lamp time is reset.

PRECAUTIONS

- Take Step 9 above within seven minutes after turning on the power.
- Be sure to reset the lamp time after replacing the lamp.
- The lamp may burst if you continue to use it without replacing while resetting the lamp time.
- Attach the lamp cover correctly so that it is not loose. If it is not attached correctly, the lamp will not come on (see  p.45).
- Always replace the lamp with a new one.
- The lamp is made out of glass. Do not touch the glass surface with your bare hands, bang it, or scratch it. (Dirt, jolts, scratches and the like could break the lamp.)

● Used lamps

This projector's lamps contain trace amounts of environmentally harmful inorganic mercury. Be careful not to break used lamps, and dispose it in accordance with local regulations.

Trouble indications

The indicator lights inform you of internal abnormalities.

<p>ON (Off) LAMP (Off) TEMP (Off) FAN (Off)</p>	<p>No power</p> <p>⇒ Problem with projector</p> <ul style="list-style-type: none"> • Unplug the power cord, and contact your dealer.
<p>ON (Red lit) LAMP (Red lit) TEMP (Off) FAN (Green lit)</p>	<p>Lamp went out during use</p> <p>⇒ Lamp temperature is high so that it is difficult to turn on, the lifetime of the lamp has ended, or the projector is malfunctioning.</p> <ul style="list-style-type: none"> • Unplug the power cord and wait for a short while, then turn the power back on. • If a lamp burns out, replace it with a new one. <p>✱ After approx. one minute of abnormal display, the projector returns to the standby state waiting for internal cool down.</p>
<p>ON (Red lit) LAMP (Red lit or flashing) TEMP (Red lit or flashing) FAN (Green lit)</p> <p>or</p> <p>(Orange lit or flashing)</p> <p>or</p> <p>(Green lit)</p>	<p>Power went out during use, or won't come on</p> <p>⇒ Internal overheating, or the outside temperature is too high.</p> <ul style="list-style-type: none"> • Replace the projector so that the air intake and exhaust are not blocked. • Unplug the power cord and wait for a short while, then turn the power back on. • Clean the air filter. (See ⇨ p.40.) <p>✱ The icon will appear before the power goes out.</p> <p>✱ After approx. two minutes of error display, the projector returns to the standby state waiting for internal cool down.</p>
<p>ON (Red lit) LAMP (Off) TEMP (Off) FAN (Red lit or flashing)</p> <p>or</p> <p>(Orange lit or flashing)</p> <p>or</p> <p>(Green lit or flashing)</p>	<p>Power went out during use, or won't come on</p> <p>⇒ Problem with internal cooling fan.</p> <ul style="list-style-type: none"> • Unplug the power cord, and contact your dealer. <p>✱ The icon will appear before the power goes out.</p> <p>✱ After approx. one minute of abnormal display, the projector returns to the standby state waiting for internal cool down.</p>
<p>ON (Red lit) LAMP (Orange flashing) TEMP (Off) FAN (Green lit)</p>	<p>Power went out during use</p> <p>⇒ The lamp cover is not properly attached.</p> <ul style="list-style-type: none"> • Unplug the power cord, and reattach the lamp cover. (See ⇨ p.42.) <p>✱ After approx. one minute of abnormal display, the projector returns to the standby state waiting for internal cool down.</p>

PRECAUTIONS

- Make sure to unplug the power cord if something goes wrong.
- If the power cord is unplugged before cooling is complete, give the lamp enough time to cool before plugging it back in. If the lamp overheats, it may fail to light. Unplugging the power cord repeatedly when the temperature is high will shorten the life of the lamp. (Even if you are not concerned about lamp lifetime, the light may not come on if you do not wait for at least three minutes.)

Before calling service personnel

If you think something is wrong, check the followings before contacting customer service.
Please see "Trouble indications" (➡ p.45) as well.

If This Happens	Check
No power	<ul style="list-style-type: none"> • Is the safety lock on? (See ➡ p.18) • Is the power cord plugged in? Is it connected to the projector? • Is the lamp cover loose? (See ➡ p.44) • Is the lamp correctly mounted? (See ➡ p.42)
Power goes out during use	<ul style="list-style-type: none"> • Is the ambient temperature high? (See ➡ p.45.) • Is the air filter clogged? (See ➡ p.45.) • Is the air intake or air exhaust blocked? (See ➡ p.45.) • Was the lamp timer reset after the lamp was replaced? (See ➡ p.44) • Was no signal being input for 10 minutes? (See ➡ p.21)
No picture	<ul style="list-style-type: none"> • Is a wrong input selected? (See ➡ p.21.) • Is the Sleep function on? (See ➡ p.26.) • Is the brightness setting minimized? (See ➡ p.32.) • Are the connections set up correctly? (See ➡ p.15, 16.) • Are all the connected devices functioning properly?
No audio	<ul style="list-style-type: none"> • Is the mute function on? (See ➡ p.26.) • Is the volume setting minimized? (See ➡ p.21.) • Are the connections set up correctly? (See ➡ p.15, 16.) • Are all the connected devices functioning properly?
Picture not displayed correctly	<ul style="list-style-type: none"> • Is the input signal supported by the projector? (See ➡ p.48, 49.) • Is the correct video mode selected? (See ➡ p.33.) • Is the correct signal format selected? (See ➡ p.33.) • Are there any problems with the signal source such as the video tape?
Picture blurred Part of picture out of focus	<ul style="list-style-type: none"> • Is the lens dirty? (See ➡ p.41.) • Is the lens focus adjusted optimally? (See ➡ p.20.) • Is the projection distance within the projector's supported range? (See ➡ p.14.) • Is the projector or its screen placement angle tilted too far? (See ➡ p.14.) • Is the sharpness or sampling phase misadjusted? (See ➡ p.32, 33.)
Image is dark	<ul style="list-style-type: none"> • Is the brightness or contrast misadjusted? (See ➡ p.32.) • Is the lamp approaching the end of its service life? (See ➡ p.36.)
Colors too light Bad shading	<ul style="list-style-type: none"> • Are the color, tint, R-gain, G-gain, or B-gain misadjusted? (See ➡ p.32.) • Is the screen dirty? • Is the lamp approaching the end of its service life? (See ➡ p.36.)
Remote control doesn't work	<ul style="list-style-type: none"> • Are the remote control's batteries drained? • Are the batteries inserted into the remote control correctly? (See ➡ p.13.) • Is the remote control being used within the effective range? (See ➡ p.13.) • Are there any obstructions between the remote control and projector? • Are there any fluorescent or other bright lights shining at the projector's infrared remote sensor?

Specifications

List of general specifications

Item		Specification
Power consumption		220 W (At standby: 1 W (AC 100 - 120 V) or 3 W (AC 220 - 240 V))
Weight		3.5 Kg
External dimensions (including protrusions)		320 × 85 × 320 (W × H × D) (Tilt stand excluded) 320 × 131 × 320 (W × H × D) (Tilt stand included)
Cabinet materials*		PC+ABS resin and ABS resin
Operating environmental conditions		Temperature: 0 to 35°C; Relative humidity: 30 to 70%
LCD panel	Display method	Three-panel transmission
	Panel size	0.5 type
	Drive system	TFT active matrix
	Number of pixels	409,920 (854 H × 480 V)
Lens		F = 2.3
Lamp		High-pressure mercury lamp
Projection screen size		32 - 120 type
Projection distance		0.74 - 3.04 m
Speaker		5 W + 5W (Stereo)
Connection terminals	COMPUTER terminal	Mini D-sub 15-pin
	Y terminal	RCA pin pack
	PB/CB terminal	RCA pin pack
	PR/CR terminal	RCA pin pack
	S-VIDEO terminal	Mini DIN 4-pin
	VIDEO terminal	RCA Pin jack, 1V (p-p), 75Ω
	AUDIO (L/R) terminals	RCA Pin jack × 2, 1.5 V (rms); 22 kΩ or more
	SERVICE terminal	Mini DIN 8 pin
AV IN terminal	Scart socket (21 pin)	

* Major parts of this product display the names of their materials in order to facilitate recycling after it becomes no longer usable.

Specifications (Continued)

List of supported signals

 Note

- If the resolution of input signals exceeds the LCD panel's maximum number of pixels, the picture is displayed expanded/compressed and thus some information may be lost or image quality may be affected. If the functions of changing the projection size and correcting the keystone distortion are used together, the screen may not be displayed properly.

■ List of supported signals (RGB signals)

This projector supports the following RGB signals. However, the screen may show flicker or streaking depending on the computer model. Please adjust the projector if this happens.
(Either execute "Auto setting" in the "Picture adjustment" menu or manually adjust picture-related items such as "Phase". (See  p.32.))

Resolution	Mode	Refresh rate (Hz)	H-frequency (kHz)	Clock (MHz)
720 x 400	720x400_85	85.039	37.927	35.500
640 x 480	VGA_60	59.940	31.469	25.175
	VGA_72	72.809	37.861	31.500
	VGA_75	75.000	37.500	31.500
	VGA_85	85.008	43.269	36.000
800 x 600	SVGA_56	56.250	35.156	36.000
	SVGA_60	60.317	37.879	40.000
	SVGA_72	72.188	48.077	50.000
	SVGA_75	75.000	46.875	49.500
	SVGA_85	85.061	53.674	56.250
832 x 624	MAC16"	74.550	49.725	57.283
1024 x 768	XGA_43i	86.957	35.522	44.900
	XGA_60	60.004	48.363	65.000
	XGA_70	70.069	56.476	75.000
	XGA_75	75.029	60.023	78.750
	XGA_85	84.997	68.667	94.500
	MAC19"	74.700	60.134	79.857
1152 x 864	SXGA1_75	75.000	67.500	108.000
1280 x 960	QuadVGA_60	60.000	60.000	108.000
	QuadVGA_85	85.002	85.938	148.500
1280 x 1024	SXGA3_60	60.020	63.981	108.000
	SXGA3_75	75.025	79.976	135.000
	SXGA3_85	85.024	91.146	157.500
1400 x 1050	SXGA+	60.012	63.973	118.094
1600 x 1200	UXGA_60	60.000	75.000	162.000
	UXGA_65	65.000	81.250	175.500
	UXGA_70	70.000	87.500	189.000
	UXGA_75	75.000	93.750	202.500
	UXGA_85	85.000	106.250	229.500
1792 x 1344	1792x1344_60	60.000	83.640	204.750
1856 x 1392	1856x1392_60	60.000	86.333	218.250
1920 x 1440	1920x1440_60	60.000	90.000	234.000

■ List of supported signals (Y/PB/PR signals)

Signal format	fh(kHz)	fv(Hz)
480i(525i)@60Hz	15.73	59.94
480p(525p)@60Hz	31.47	59.94
576i(625i)@50Hz	15.63	50.00
576p(625p)@50Hz	31.25	50.00
720p(750p)@60Hz	45.00	60.00
720p(750p)@50Hz	37.50	50.00
1080i(1125i)@60Hz	33.75	60.00
1080i(1125i)@50Hz	28.13	50.00
1035i(1125i)@60Hz	33.75	60.00
1152i(1250i)@50Hz	31.25	50.00

■ List of supported signals (Video and S-Video signals)

Video mode	fh(kHz)	fv(Hz)	fsc(MHz)
NTSC	15.73	60	3.58
PAL	15.63	50	4.43
SECAM	15.63	50	4.25 or 4.41
PAL-M	15.73	60	3.58
PAL-N	15.63	50	3.58
PAL-60	15.73	60	4.43
NTSC4.43	15.73	60	4.43

Pin assignment of COMPUTER terminal

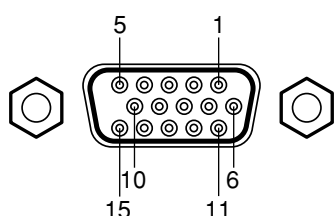

Mini D-sub 15-pin connector

Pin No.	Pin description	Pin No.	Pin description
1	Video signal (R)	9	N.C
2	Video signal (G)	10	GND
3	Video signal (B)	11	GND
4	GND	12	N.C
5	GND	13	Horizontal sync signal
6	GND(R)	14	Vertical sync signal
7	GND(G)	15	N.C
8	GND(B)		

Input signal

- RGB input
 - R/G/B signals: 0.7 V (p-p), 75Ω
 - Horizontal sync signal: TTL level (Positive/negative polarity)
 - Vertical sync signal: TTL level (Positive/negative polarity)

Separately sold product

Replacement lamp

Model TLPLET1

Note

- Designs and specifications are subject to change without notice for improvements.

TOSHIBA CORPORATION